

Hardware-in-the-Loop Validation of the Frequency Divider Formula

Álvaro Ortega*, *Member, IEEE*, Aysar Musa†, *Member, IEEE*, Antonello Monti†, *Senior Member, IEEE*,
Federico Milano*, *Fellow, IEEE*

* School of Electrical and Electronic Engineering,
University College Dublin, Ireland
{alvaro.ortegamanjavacas, federico.milano}@ucd.ie

† E.ON Energy Research Center,
RWTH Aachen University, Germany
{amusa, amonti}@eonerc.rwth-aachen.de

Abstract—This paper validates a theoretical approach, namely, the *frequency divider formula*, recently proposed by the first and fourth authors to estimate local frequency variations based on the synchronous machine rotor speeds and on signals from phasor measurement units (PMUs). The validation is based on simulations performed in a Real-Time Digital Simulator with physical PMUs connected in the loop. The case study considers the well-known WSCC 3-machine, 9-bus test system. Simulation results show the high accuracy of the frequency divider formula to estimate the frequency at every bus of the network. Results also show that the frequency divider prevents the numerical issues due to fast variations of the voltage when measured by the PMU and indicate that such a formula can be utilized to test the fidelity of PMU implementations.

I. INTRODUCTION

In recent years, there has been a growing interest in the provision of frequency control by non-conventional, typically power converter-based power system devices. These include Wind Energy Conversion Systems (WECSS) [1], [2], Solar Photo-Voltaic Generations (SPVGS) [3], [4], Energy Storage Systems (ESSs) [5], [6], High-Voltage Direct Current (HVDC) systems [7], [8], and Thermostatically Controlled Loads (TCLs) [9], [10], among others. In practice, the frequency signal used as input of the controller can be provided by the Phase-Locked Loop (PLL) needed to synchronize the converter with the grid [11], [12], or by Phasor Measurement Units (PMUs) connected at the point of coupling with the grid [13], [14]. However, from the simulation point of view, accurately estimating the local frequency to be regulated is still an open and urgent problem.

In off-line analyses and simulations, the frequency of the Centre of Inertia (COI) has been considered as a good candidate to estimate system frequency variations [15]–[17]. The main advantages of referring machine speed deviations to the frequency of the COI is that it prevents the drift of machine angles, which is particularly critical in long term stability analysis [18]. For these reasons, the COI is implemented in most commercial software tools for the dynamic simulation of power systems, e.g., Eurostag and PSS/E.

Unfortunately, the frequency of the COI cannot be estimated in on-line applications and only very recently a technique to solve this issue has been proposed [19]. Apart from practical issues, the COI naturally also filters local variations

that, if neglected, can lead to a response of the frequency controller that differs from the actual one [20], [21]. This is the main obstacle that prevents, in simulations, the utilization of the COI as the frequency signal for the primary frequency control of distributed resources. To tackle this issue, several alternatives to estimate the local frequency have been proposed in the literature.

A variety of models of PLL for transient stability studies are provided and compared in [22], [23]. PLLs provide an estimation of the frequency variations at the point of connection, based on the numerical derivative of the bus voltage angle. However, the PLL signal is characterized by high levels of noise and numerical issues, specially during discontinuous events such as faults or line outages [20].

In [24] a frequency propagation, center-of-gravity based approach to estimate local and global frequency variations is proposed. While this method is appropriate to estimate long-term power and frequency behavior, it may not be adequate for short-time studies, since fast inter-unit synchronizing oscillations are filtered out.

To prevent the numerical issues of PLLs, and to improve the accuracy of the estimation for short-term studies, the authors have proposed in [25] the Frequency Divider Formula (FDF). The FDF provides an *ideal* estimation of the local frequency variations at every bus of the transmission system, based on the augmented admittance matrix of the system, and the rotor speeds of the machines and PMU measurements from interconnection buses.

The mathematical formulation and assumptions of the FDF have been duly described in [25], and the relevance of using such a formula for transient stability studies has been properly discussed in [20], [21]. However, to date, the FDF has not been tested and validated by means of, e.g., real data or digital real-time simulators with fully-fledged Electromagnetic Transients (EMT) models. This paper fills this gap, and validates the FDF through simulations performed in a Real-Time Digital Simulator (RTDS)–PMU set-up using hardware-in-the-loop.

The paper is organized as follows. Section II provides a brief description of the FDF. A detailed description of the RTDS–PMU set-up is provided in Section III. The case study, based on the well-known WSCC 9-bus test system, is presented in Section IV. Finally, Section V draws conclusions.

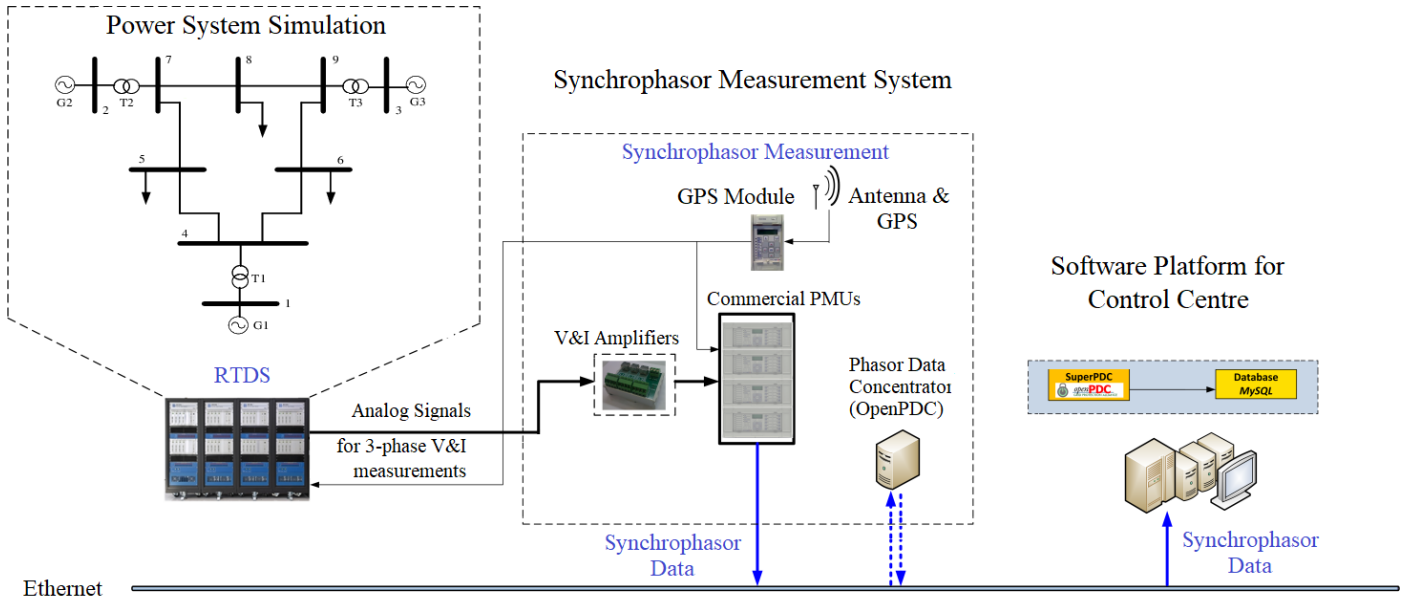

Fig. 1: RTDS-PMU set-up.

II. FREQUENCY DIVIDER FORMULA

In [25], a new technique to estimate local frequency variations at every bus of a given network is proposed. This technique, called *Frequency Divider Formula* (FDF), relates such local variations with synchronous machine rotor speeds and PMU measurements by means of the augmented admittance matrix of the system, as formulated below.

$$\omega_U = \mathbf{1} - (\mathbf{B}_{UU} + \mathbf{B}_{U0})^{-1} [\mathbf{B}_{UG} \quad \mathbf{B}_{UM}] \begin{bmatrix} \omega_G - \mathbf{1} \\ \omega_M - \mathbf{1} \end{bmatrix} \quad (1)$$

where ω_U are the unknown bus frequencies; ω_G are the synchronous machine rotor speeds; ω_M are PMU measurements; and \mathbf{B}_{UU} , \mathbf{B}_{U0} , \mathbf{B}_{UG} , and \mathbf{B}_{UM} are system susceptance matrices.

For computational efficiency purposes, it is advisable to formulate (1) as an acausal expression, as follows:

$$\mathbf{0} = (\mathbf{B}_{UU} + \mathbf{B}_{U0}) \cdot (\omega_U - \mathbf{1}) + \mathbf{B}_{UG} \cdot (\omega_G - \mathbf{1}) + \mathbf{B}_{UM} \cdot (\omega_M - \mathbf{1}) \quad (2)$$

The main advantage of the above formulation is the avoidance of computing $(\mathbf{B}_{UU} + \mathbf{B}_{U0})^{-1}$, which results on an almost fully dense matrix. This is particularly relevant when large systems are considered. Moreover, the frequency estimation provided by (2) is free of numerical issues such as the spikes after discontinuous events that characterize the frequency signals provided by PLLs and PMUs.

The expressions in (1) and (2) are certainly accurate for standard transient stability models and simulations, as thoroughly discussed in [20], [21], [25]. However, a validation of the FDF considering EMT models and real-world frequency estimators appears necessary and timely as (1) and (2) are obtained starting from a set of hypothesis and simplifications, the most relevant of which is that fast electromagnetic dynamics are neglected. How such transients impact on the actual deviations of the fundamental frequency of the system has not been fully investigated. The setup of a test system for such a validation is discussed in the next section.

III. RTDS-PMU SET-UP

A real-time power system monitoring platform is used in this work, as shown in Fig. 1 [26]. It is composed of three main stages:

- i. *Real-Time Digital Simulator (RTDS)*: real-time power system simulation is performed within RTDS to create and study different test scenarios. The obtained system measurements are exported from RTDS via its analog output interface, i.e. its communication board, and scripted as if the measurements were provided by in field device. These measurements are sent through Distributed Network Protocol (DNP3) format and, through scripts, they are captured and saved into text files. The RTDS uses RSCAD as a graphical user interface software. The 9-bus system has been modeled in RSCAD and simulated under different test scenarios.
- ii. *Synchrophasor Measurement System*: the PMU uses the voltage and current measurements, from the analog output of RTDS, to provide the phasor measurements. Then, these phasor measurements are synchronized with Global Positioning Satellite (GPS) signal according to IEEE synchrophasor standards [27], [28]. The schematic diagram of PMU structure is depicted in Fig. 2 [29]. The Open source software Phasor Data Concentrator (OPENPDC) and Super-PDC are installed to aggregate, store, and stream the phasor measurement data via Ethernet network. The GPS receiver receives one pulse-per-second (pps) signal from GPS antenna. This signal is used to synchronize the clock of Phase-Locked Oscillator, which in turn, provides clocking signals to synchronize the clocks of analog to digital converter (A/D converter) and phasor calculator, such that the calculated phasors are time tagged. Finally, the calculated phasors are published through Ethernet port in standard synchrophasor format as defined in [27], [28]. In the presented

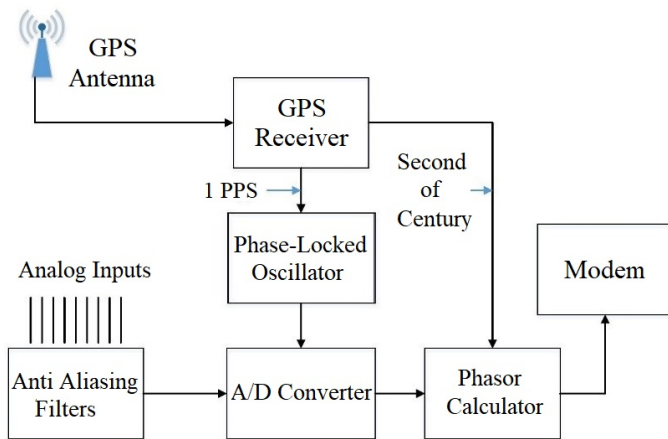

Fig. 2: Schematic diagram of PMU structure.

monitoring platform, four commercial Alstom-PMUs (MiCOM P847) are used. The GPS unit is used to provide the accurate timing signals, through fiber optic cables, to all the four PMUs. The PMUs are used to provide the synchrophasor measurements of the 9-bus system frequency, as duly explained in Section IV.

- iii. *Software Platform for Control Centre:* this stage is responsible for collecting the measurements, providing a common data storage point, and providing a platform for developing the monitoring and control application. This platform supports multiple applications for monitoring, analysis, and control purposes. These applications could be executed in the control center.

IV. CASE STUDY

In this section, the accuracy of the FDF described in Section II is validated. To this aim, the well-known WSCC 9-bus, 3-machine test system is considered. This benchmark network is composed of three synchronous machines, loads and transformers, and six transmission lines. The system also includes primary frequency and voltage regulation, i.e., Turbine Governors (TGs) and Automatic Voltage Regulators (AVRs), as well as secondary frequency regulation, i.e., an Automatic Generation Control (AGC). The scheme of the WSCC 9-bus system is shown in Fig. 3 and static and dynamic data can be found in [30].

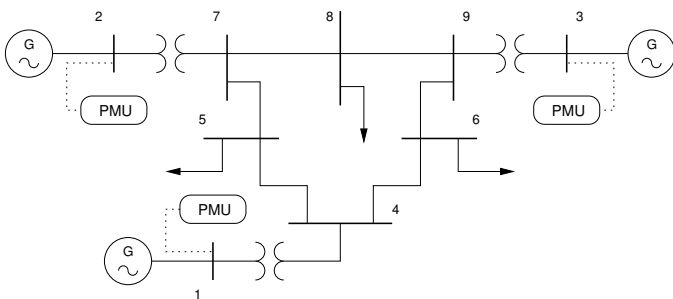

Fig. 3: Scheme of the WSCC 9-bus test system.

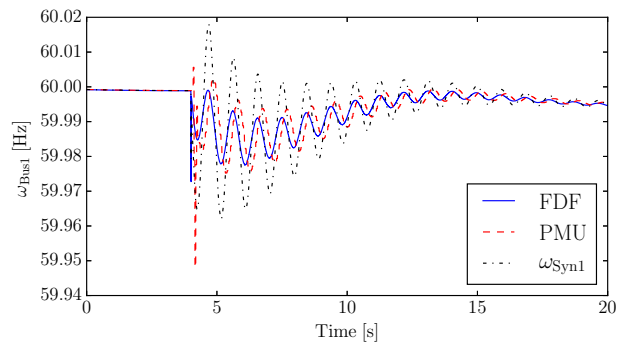

Fig. 4: Synchronous machine rotor speed and frequency measured and estimated at bus 1.

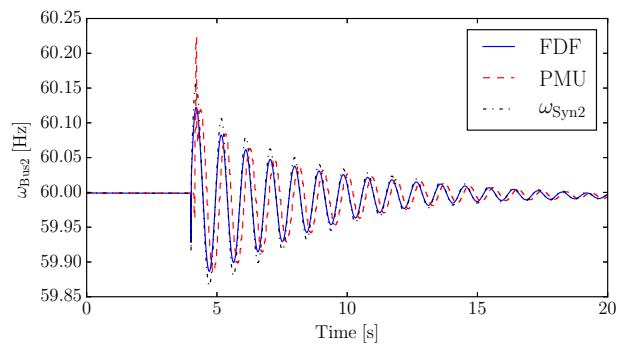

Fig. 5: Synchronous machine rotor speed and frequency measured and estimated at bus 2.

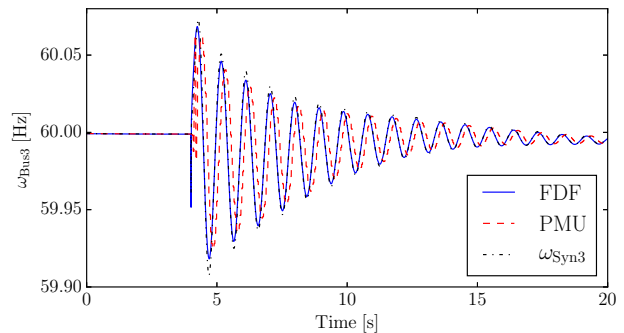

Fig. 6: Synchronous machine rotor speed and frequency measured and estimated at bus 3.

The frequency signals estimated through the FDF are compared to the machine rotor speeds obtained by means of a RTDS using EMT models of the 9-bus test system, and with PMU bus frequency measurements. The contingency is a three-phase fault, located at bus 7. The fault, with a reactance of 10^{-5} p.u. (Ω), is cleared after 70 ms.

The rotor speed of the machines, and the frequencies of buses 1, 2 and 3 measured and estimated by means of the PMUs and the FDF are represented in Figs. 4, 5 and 6, respectively.

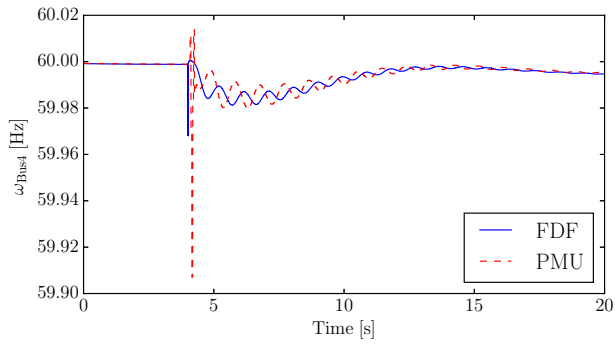

Fig. 7: Frequency measured and estimated at bus 4.

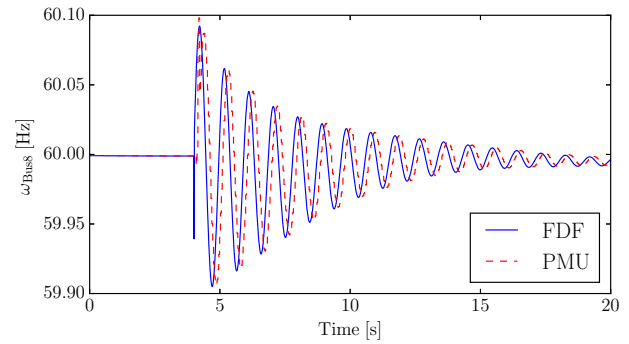

Fig. 10: Frequency measured and estimated at bus 8.

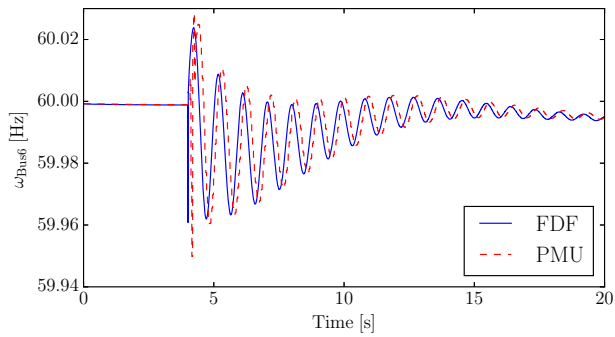

Fig. 8: Frequency measured and estimated at bus 6.

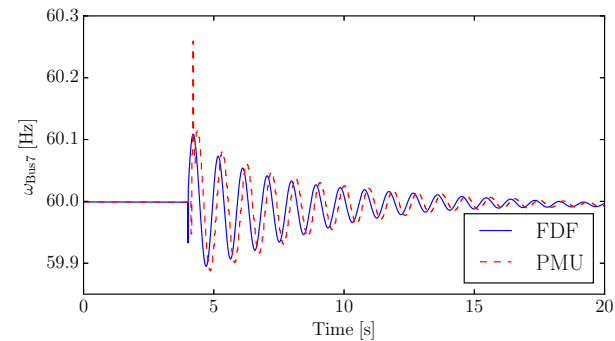

Fig. 9: Frequency measured and estimated at bus 7.

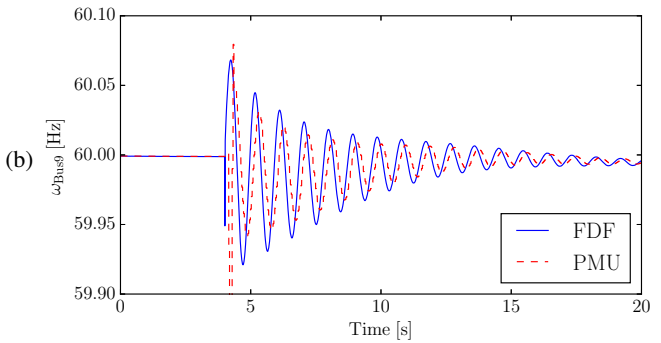
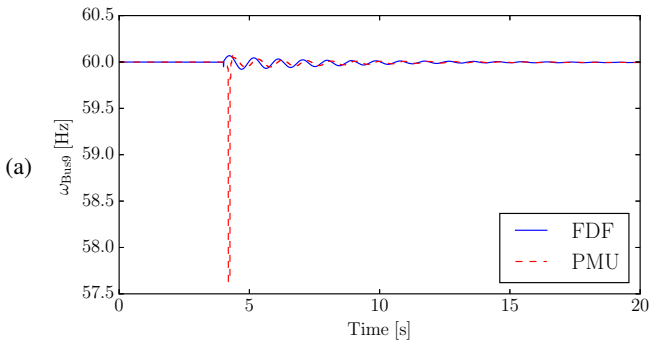

Fig. 11: Frequency measured and estimated at bus 9.

It can be seen that the amplitude of the oscillations of the frequencies estimated by means of the FDF and the PMU measurements are very similar. However, the oscillations of PMU signals show a delay with respect to those of the rotor speed of the machine. The delay is due to the implementation of the frequency estimator within the PMU devices. This is based on a PLL which, to filter noise, and due to measurement and sampling issues, cannot provide a perfectly instantaneous estimation of the frequency.

PMU signals also show *spikes* which are triggered by large and fast variations of the bus voltages during the transient. These spikes are due to the computation of the numerical derivative of the bus voltage measure. It is interesting to note

that such spikes are very similar to those observed in [20], [21], [25]. In these references, however, the model utilized to simulate the network is a standard quasi-static phasor model for transient stability analysis. It is interesting to note that the EMT model utilized in this case study leads to similar discontinuities of the frequencies estimated through the PMUs.

On the other hand, the frequency swings of the FDF estimations show no spikes, and no delay, and thus they are in phase with the machine rotor speeds. Note that the difference of the oscillation amplitudes between the machine rotor speed and the frequency at the bus of connection is due to the internal impedance of the synchronous machine. The frequency measured and estimated at the remaining system buses are depicted in Figs. 7 – 11.

V. CONCLUSIONS

The paper validates the accuracy of the frequency divider formula through a real-time simulator with hardware-in-the-loop. The bus frequencies of the WSCC 9-bus test system facing a severe contingency, i.e., a three-phase fault followed by a line outage, have been estimated using the FDF and compared to those of detailed EMT models as well as of PMU measurements. Results show that the approximations and hypothesis on which the FDF is based do not affect its accuracy. On the contrary, the FDF can be utilized to evaluate the fidelity of the frequency estimation of PMU and PLL devices. In particular, the FDF allows measuring the delay and the errors (e.g., spikes) introduced by fast varying phasors. Future work will focus on the utilization of the FDF formula for the calibration and the tuning of PLL parameters to improve the on-line estimation of local frequencies.

ACKNOWLEDGMENTS

This material is based upon works supported by the European Commission, by funding Á. Ortega, A. Musa, A. Monti and F. Milano, under the RESERVE Consortium (grant No. 727481). F. Milano is also funded by the Science Foundation Ireland, under Investigator Programme, Grant No. SFI/15/IA/3074, and a beneficiary of the EC Marie Skłodowska-Curie CIG No. PCIG14-GA-2013-630811.

REFERENCES

- [1] G. Ramtharan, J. B. Ekanayake, and N. Jenkins, "Frequency Support from Doubly Fed Induction Generator Wind Turbines," *IET Renewable Power Generation*, vol. 1, no. 1, pp. 3–9, March 2007.
- [2] J. M. Mauricio, A. Marano, A. Gómez-Expósito, and J. L. M. Ramos, "Frequency Regulation Contribution Through Variable-Speed Wind Energy Conversion Systems," *IEEE Transactions on Power Systems*, vol. 24, no. 1, pp. 173–180, Feb 2009.
- [3] B. Tamimi, C. Caizares, and K. Bhattacharya, "Modeling and Performance Analysis of Large Solar Photo-Voltaic Generation on Voltage Stability and Inter-area Oscillations," in *2011 IEEE Power and Energy Society General Meeting*, July 2011, pp. 1–6.
- [4] H. S. Ko, G. G. Yoon, and W. P. Hong, "Active Use of DFIG-Based Variable-Speed Wind-Turbine for Voltage Regulation at a Remote Location," *IEEE Transactions on Power Systems*, vol. 22, no. 4, pp. 1916–1925, Nov 2007.
- [5] K. Yang and A. Walid, "Outage-Storage Tradeoff in Frequency Regulation for Smart Grid With Renewables," *IEEE Transactions on Smart Grid*, vol. 4, no. 1, pp. 245–252, March 2013.
- [6] M. Swierczynski, D. Stroe, A.-I. Stan, R. Teodorescu, and D. Sauer, "Selection and Performance-Degradation Modeling of $\text{LiMO}_2/\text{Li}_4\text{Ti}_5\text{O}_{12}$ and LiFePO_4/C Battery Cells as Suitable Energy Storage Systems for Grid Integration With Wind Power Plants: An Example for the Primary Frequency Regulation Service," *IEEE Transactions on Sustainable Energy*, vol. 5, no. 1, pp. 90–101, Jan 2014.
- [7] C. Taylor and S. Lefebvre, "HVDC Controls for System Dynamic Performance," *IEEE Transactions on Power Systems*, vol. 6, no. 2, pp. 743–752, May 1991.
- [8] L. Castro and E. Acha, "On the Provision of Frequency Regulation in Low Inertia AC Grids Using HVDC Systems," *IEEE Transactions on Smart Grid*, vol. PP, no. 99, pp. 1–11, 2015.
- [9] S. Kundu, N. Sinitsyn, I. Hiskens, and S. Backhaus, "Modeling and Control of Thermostatically Controlled Loads," in *17th Power Systems Computation Conference 2011, (PSCC 2011 STOCKHOLM)*, 2011, pp. 969–975.
- [10] S. E. Z. Soudjani and A. Abate, "Aggregation of Thermostatically Controlled Loads by Formal Abstractions," in *Control Conference (ECC), 2013 European*, 2013, pp. 4232–4237.
- [11] H. Karimi, M. Karimi-Ghartemani, and M. R. Iravani, "Estimation of Frequency and its Rate of Change for Applications in Power Systems," *IEEE Trans. on Power Delivery*, vol. 19, no. 2, pp. 472–480, April 2004.
- [12] F. Blaabjerg, R. Teodorescu, M. Liserre, and A. V. Timbus, "Overview of Control and Grid Synchronization for Distributed Power Generation Systems," *IEEE Trans. on Industrial Electronics*, vol. 53, no. 5, pp. 1398–1409, Oct 2006.
- [13] K. Emami, T. Fernando, H. H. C. Iu, B. D. Nener, and K. P. Wong, "Application of Unscented Transform in Frequency Control of a Complex Power System Using Noisy PMU Data," *IEEE Transactions on Industrial Informatics*, vol. 12, no. 2, pp. 853–863, April 2016.
- [14] D. I. Kim, T. Y. Chun, S. H. Yoon, G. Lee, and Y. J. Shin, "Wavelet-Based Event Detection Method Using PMU Data," *IEEE Transactions on Smart Grid*, vol. 8, no. 3, pp. 1154–1162, May 2017.
- [15] C. J. Tavora and O. J. M. Smith, "Characterization of Equilibrium and Stability in Power Systems," *IEEE Transactions on Power Apparatus and Systems*, vol. PAS-91, no. 3, pp. 1127–1130, May 1972.
- [16] P. W. Sauer and M. A. Pai, *Power System Dynamics and Stability*. Upper Saddle River, NJ: Prentice Hall, 1998.
- [17] F. Milano, *Power System Modelling and Scripting*. London: Springer, 2010.
- [18] D. Fabbiozzi and T. V. Cutsem, "On Angle References in Long-Term Time-Domain Simulations," *IEEE Transactions on Power Systems*, vol. 26, no. 1, pp. 483–484, Feb. 2011.
- [19] F. Milano, "Rotor Speed-free Estimation of the Frequency of the Center of Inertia," *IEEE Transactions on Power Systems*, vol. PP, no. 99, pp. 1–1, 2017.
- [20] Á. Ortega and F. Milano, "Comparison of Bus Frequency Estimators for Power System Transient Stability Analysis," in *International Conference on Power System Technology (POWERCON)*, Wollongong, Australia, Sept. 2016.
- [21] —, "Impact of Frequency Estimation for VSC-based Devices with Primary Frequency Control," in *IEEE International Conference on Innovative Smart Grid Technologies (IEEE ISGT Europe)*, Turin, Italy, Sept. 2017.
- [22] R. Teodorescu, M. Liserre, and P. Rodríguez, *Grid Converters for Photovoltaic and Wind Power Systems*. Chichester, UK: Wiley, 2011.
- [23] A. Nicastrì and A. Nagliero, "Comparison and Evaluation of the PLL Techniques for the Design of the Grid-connected Inverter Systems," in *2010 IEEE International Symposium on Industrial Electronics*, July 2010, pp. 3865–3870.
- [24] H. Golpira and A. R. Messina, "A Center-of-Gravity-based Approach to Estimate Slow Power and Frequency Variations," *IEEE Transactions on Power Systems*, vol. PP, no. 99, pp. 1–1, 2017.
- [25] F. Milano and Á. Ortega, "Frequency Divider," *IEEE Transactions on Power Systems*, vol. 32, no. 2, pp. 1493–1501, March 2017.
- [26] A. Sadu, "Development of Real-time Simulation Platform for Power System Monitoring," Master's thesis, Faculty of Electrical Engineering and Information Technology, RWTH Aachen University, Aachen, Germany, 2014.
- [27] "IEEE Standard for Synchrophasor Measurements for Power Systems," *IEEE Std C37.118.1-2011 (Revision of IEEE Std C37.118-2005)*, pp. 1–61, Dec 2011.
- [28] "IEEE Standard for Synchrophasors for Power Systems," *IEEE Std C37.118-2005 (Revision of IEEE Std 1344-1995)*, pp. 1–57, 2006.
- [29] A. G. Phadke and J. S. Thorp, *Synchronized Phasor Measurements and Their Applications*, ser. Power Electronics and Power Systems. Springer US, 2008.
- [30] P. M. Anderson and A. A. Fouad, *Power System Control and Stability*, 2nd ed. New York, NY: Wiley-IEEE Press, 2002.