

# SOLVING POWER AND OPTIMAL POWER FLOW PROBLEMS IN THE PRESENCE OF UNCERTAINTY BY AFFINE ARITHMETIC

Alfredo Vaccaro



University College Dublin – October 22, 2015



# RESEARCH MOTIVATIONS

- Power Flow (PF) and Optimal Power Flow (OPF) are the mathematical backbone of many power engineering applications:
  - » State estimation.
  - » Network optimization.
  - » Unit commitment.
  - » Voltage control.
  - » Generation dispatch.
  - » Market studies.



# RESEARCH MOTIVATIONS

- Solving PF and OPF problems request in considering system uncertainties, which are mainly related to:
  - » Variable nature of generation dispatch.
  - » Increasing number of smaller geographically dispersed generators.
  - » Difficulties arising for predicting and modeling market operator behavior.
  - » High penetration of generation units powered by renewable energy sources.



# RESEARCH MOTIVATIONS

- Reliable solutions are required to provide insight into the level of confidence of PF/OPF solutions by:
  - » Estimating the data tolerance (i.e. uncertainty characterization).
  - » Computing the solution tolerance (i.e. uncertainty propagation assessment).
  - » Performing sensitivity analysis of large parameters variations.



# LITERATURE REVIEW

- Sampling-based methods:
  - » Require several model runs that sample various combinations of input values.
  - » Shortcomings:
    - Need high computational resources.
    - Some sampling techniques reduce the number of model runs at the cost of accepting some risk.



# LITERATURE REVIEW

- Analytical methods:
  - » Computationally more effective, but require some mathematical assumptions in order to:
    - Simplify the problem.
    - Obtain an effective characterization of the output random variables.
  - » Shortcomings:
    - Assumes statistical independence of the input data.
    - Need to identify probability distributions for some input data, which is not always possible in PF and OPF.



# LITERATURE REVIEW

- Approximate methods:
  - » Approximate the statistical proprieties of the output random variables.
  - » These overcome some of the main limitations of sampling-based and analytical methods.
  - » Shortcomings:
    - Do not provide acceptable results in the presence of a large number of input random variables.
    - Selection of the number of estimated points is still an open problem.



# LITERATURE REVIEW

- Non-Probabilistic paradigms:
  - » Can be adopted when:
    - Uncertainty originates from imprecise human knowledge about the system.
    - Only imprecise estimates of values and relations between variables are available.
  - » The most advanced models are based on:
    - Theory of possibility.
    - Theory of evidence.
    - Theory of self-validated computing.





# LITERATURE REVIEW

- Self-validated computing:
  - » Keeps track of the accuracy of the computed quantities without requiring information about the type of uncertainty.
  - » The simplest and most popular of these models is Interval Mathematic (IM).



# LITERATURE REVIEW

- Interval Mathematic:
  - » Each quantity is represented by an interval of floating point numbers without a probability structure.
  - » Such intervals are processed so that each computed interval is guaranteed to contain the unknown value of the quantity it represents.
  - » Shortcomings:
    - Over-estimation of the true range of complex functions (dependency problem/wrapping effect).
    - It can lead to an unwanted expansion of the resulting intervals (error explosion problem).



# ELEMENTS OF IA

**Theorem 1** (Fundamental invariant of range analysis for IA):  $\forall \Gamma : \mathbb{R}^p \rightarrow \mathbb{R}^q$ , *globally Lipschitz with bounded slope*. There exists an interval extension  $\Gamma^I : \mathbb{R}^p \rightarrow \mathbb{R}^q$  such that:

$$\forall (\theta_1, \dots, \theta_p) \in (\Theta_1, \dots, \Theta_p) \Rightarrow \Gamma(\theta_1, \dots, \theta_p) \in \Gamma^I(\Theta_1, \dots, \Theta_p) \quad \blacksquare$$

$$\Theta_1 + \Theta_2 = [\theta_{1,inf} + \theta_{2,inf}, \theta_{1,sup} + \theta_{2,sup}]$$

$$\Theta_1 - \Theta_2 = [\theta_{1,inf} - \theta_{2,sup}, \theta_{1,sup} - \theta_{2,inf}]$$

$$\Theta_1 \cdot \Theta_2 = [\min(\theta_{1,inf}\theta_{2,inf}, \theta_{1,inf}\theta_{2,sup}, \theta_{1,sup}\theta_{2,inf}, \theta_{1,sup}\theta_{2,sup}), \\ \max(\theta_{1,inf}\theta_{2,inf}, \theta_{1,inf}\theta_{2,sup}, \theta_{1,sup}\theta_{2,inf}, \theta_{1,sup}\theta_{2,sup})]$$

$$\Theta_1 / \Theta_2 = [\theta_{1,inf}, \theta_{1,sup}] \cdot \left[ \frac{1}{\theta_{2,sup}}, \frac{1}{\theta_{2,inf}} \right] \quad 0 \notin [\theta_{2,inf}, \theta_{2,sup}]$$



# EXAMPLE OF THE “WRAPPING” EFFECT

$$\Theta_1 \cdot (\Theta_2 + \Theta_3) \subset (\Theta_1 \cdot \Theta_2 + \Theta_1 \cdot \Theta_3)$$



# EXAMPLE OF THE “WRAPPING” EFFECT (HARMONIC OSCILLATOR)

$$\dot{\theta}_1 = \theta_2, \quad \dot{\theta}_2 = -\theta_1,$$

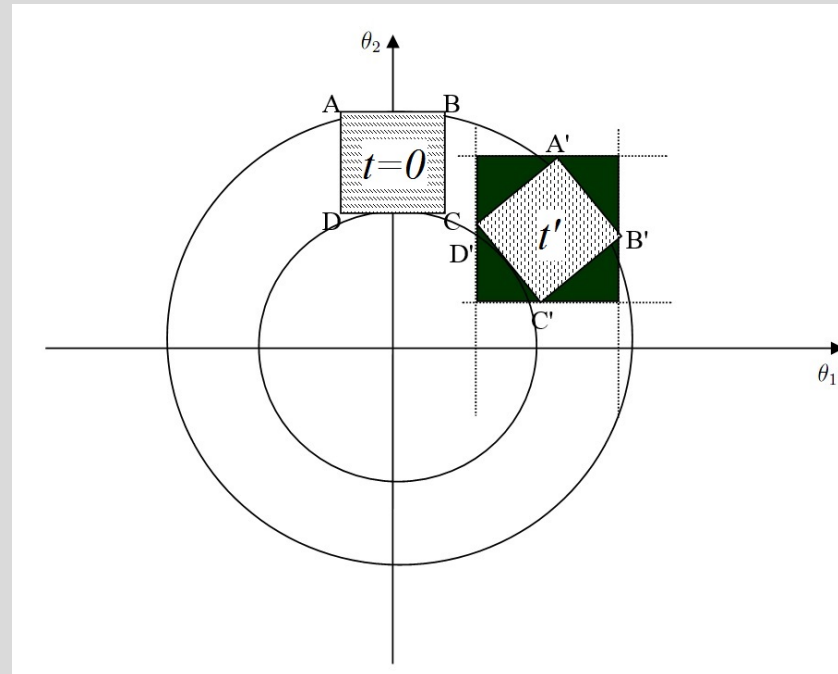

IA evolution of the external surface of the region of uncertainty for a 2-nd order oscillatory system (“wrapping” effect)



# EXAMPLE OF THE DEPENDENCY PROBLEM

$$\Theta - \Theta = [\theta_{inf}, \theta_{sup}] - [\theta_{inf}, \theta_{sup}] = [\theta_{inf} - \theta_{sup}, \theta_{sup} + \theta_{inf}] \neq 0$$



# LITERATURE REVIEW

- Affine Arithmetic (AA):
  - » It is an enhanced model for self validated numerical analysis.
  - » The quantities are represented as affine combinations of certain primitive variables, that stand for:
    - Sources of uncertainty in the data.
    - Approximations made during the computation.
  - » Unlike IM, it keeps track of correlations between computed and input quantities, hence, there is no dependency problems and reduce wrapping effects.
  - » We have led its application to PF and OPF.



# LITERATURE REVIEW

- Although several papers demonstrated the important role played by AA in power systems analysis, several open problems remain unsolved:
  - » Further explore the application of AA-based techniques to uncertain OPF analysis.
  - » Better methodologies are needed for selecting the noise symbols of the affine forms.
  - » More efficient techniques needed to reduce overestimation errors.





# RESEARCH OBJECTIVES

1. Demonstrate with several realistic test systems that the use IA in PF and OPF analysis leads to over-pessimistic estimation of the solution hull, and analyze the employment of AA to represent the uncertainties of the power systems state variables.
2. Present and thoroughly test solution methodologies based on AA for PF and OPF studies with data uncertainties.
3. Conceptualize a unified AA-based computational paradigm aimed at solving both PF and OPF problems in the presence of data uncertainties.



# RESEARCH OBJECTIVES

4. Design more effective computing paradigms to reduce computational requirements by knowledge discovery from historical operating data-sets, and use this approach to better identify the noise symbols of the affine forms describing the uncertain parameters in the proposed AA-based PF and OPF analyses.



# BACKGROUND

- In AA a partially unknown quantity  $\hat{x}$  is represented by an affine form which is a first degree polynomial:

$$\hat{x} = x_0 + x_1 \varepsilon_1 + x_2 \varepsilon_2 + \dots + x_n \varepsilon_n$$

Partial deviations

Central Value

Noise symbols  
( interval [-1,1])



# BACKGROUND

- Affine operations:

$$\hat{x} \pm \lambda = (x_0 \pm \lambda) + x_1 \varepsilon_1 + x_2 \varepsilon_2 + \dots + x_n \varepsilon_n \quad \forall \lambda \in \mathbb{R}$$

$$\hat{x} \pm \hat{y} = (x_0 \pm y_0) + (x_1 \pm y_1) \varepsilon_1 + (x_2 \pm y_2) \varepsilon_2 + \dots + (x_n \pm y_n) \varepsilon_n$$

$$\alpha \hat{x} = (\alpha x_0) + (\alpha x_1) \varepsilon_1 + (\alpha x_2) \varepsilon_2 + \dots + (\alpha x_n) \varepsilon_n \quad \forall \alpha \in \mathbb{R}$$



# BACKGROUND

- Non-affine operations:

$$\hat{z} = f(\hat{x}, \hat{y}) = f(x_0 + x_1\mathcal{E}_1 + x_2\mathcal{E}_2 + \dots + x_n\mathcal{E}_n, y_0 + y_1\mathcal{E}_1 + y_2\mathcal{E}_2 + \dots + y_n\mathcal{E}_n) = f^*(\mathcal{E}_1, \mathcal{E}_2, \dots, \mathcal{E}_n)$$

- » The problem can be lead to the identification of an affine function:

$$f^a(\mathcal{E}_1, \mathcal{E}_2, \dots, \mathcal{E}_n) = z_0 + z_1\mathcal{E}_1 + \dots + z_n\mathcal{E}_n$$

that approximates the function reasonably well over its domain, with an extra term that represents the error introduced by this approximation:

$$\hat{z} = f^a(\mathcal{E}_1, \mathcal{E}_2, \dots, \mathcal{E}_n) + z_k\mathcal{E}_k = z_0 + z_1\mathcal{E}_1 + \dots + z_n\mathcal{E}_n + z_k\mathcal{E}_k$$



# BACKGROUND

**Theorem 2** (Chebyshev approximation theorem for univariate functions): *Let  $\Gamma$  be a bounded and twice differentiable function defined in some interval  $\chi^I = [\chi_{inf}, \chi_{sup}]$ , whose second derivative does not change sign inside  $\chi$ . Let  $\Gamma^a(\hat{\chi}) = \alpha\hat{\chi} + \xi$  be its Chebyshev affine approximation in  $\chi^I$ . Then:*

$$\alpha = \frac{\Gamma(\chi_{sup}) - \Gamma(\chi_{inf})}{\chi_{sup} - \chi_{inf}} \quad \xi = \frac{\Gamma(u) + r(u)}{2} - \alpha u \quad \frac{d\Gamma(u)}{d\chi} = \alpha \quad r(u) = \alpha u + \Gamma(\chi_{sup}) - \alpha\chi_{sup}$$

and the maximum absolute error is:

$$\zeta_{p+1} = \left| \frac{\Gamma(u) - r(u)}{2} \right| \quad \blacksquare$$



# AA-BASED PF

- Each power system state variable is expressed by a central value and a set of partial deviations.
- These deviations are associated with noise symbols that describe the effect of the various uncertainties affecting the system state variables, such as P and Q variations.



# AA-BASED PF

- The affine forms representing the power systems state variables are:

$$V_i = V_{i,0} + \sum_{j \in N_P} V_{i,j}^P \varepsilon_{P_j} + \sum_{k \in N_Q} V_{i,k}^Q \varepsilon_{Q_k} \quad \forall i \in N_Q$$
$$\delta_i = \delta_{i,0} + \sum_{j \in N_P} \delta_{i,j}^P \varepsilon_{P_j} + \sum_{k \in N_Q} \delta_{i,k}^Q \varepsilon_{Q_k} \quad \forall i \in N_P$$

- The central values of the affine forms are calculated by solving a conventional PF problem for a “nominal operating point” defined by:

$$P_i^{SP} = \text{mid} \left( \left[ P_{i,\min}^{SP}, P_{i,\max}^{SP} \right] \right) = \frac{P_{i,\max}^{SP} - P_{i,\min}^{SP}}{2} \quad \text{for } i \in N_P$$
$$Q_i^{SP} = \text{mid} \left( \left[ Q_{i,\min}^{SP}, Q_{i,\max}^{SP} \right] \right) = \frac{Q_{i,\max}^{SP} - Q_{i,\min}^{SP}}{2} \quad \text{for } i \in N_Q$$





# AA-BASED PF

- A first estimation of the partial deviations of the affine forms are calculated by sensitivity analysis.

$$\begin{aligned} V_{i,j}^P &= \left. \frac{\partial V_i}{\partial P_j} \right|_0 \Delta P_j & V_{i,k}^Q &= \left. \frac{\partial V_i}{\partial Q_k} \right|_0 \Delta Q_k & \forall j \in \mathcal{N}_P, \forall \|\cdot\| \in \mathcal{N}_Q \\ \delta_{i,j}^P &= \left. \frac{\partial \delta_i}{\partial P_j} \right|_0 \Delta P_j & \delta_{i,k}^Q &= \left. \frac{\partial \delta_i}{\partial Q_k} \right|_0 \Delta Q_k & \forall i, j \in \mathcal{N}_P, \forall \|\cdot\| \in \mathcal{N}_Q \end{aligned}$$

- To guarantee the inclusion of the solution domain each partial deviation is multiplied by an amplification coefficient.



# AA-BASED PF

$$\begin{aligned}\hat{Q}_i &= Q_{i,0} + \sum_{j \in \mathcal{N}_{\mathcal{P}}} Q_{i,j}^P \varepsilon_j + \sum_{k \in \mathcal{N}_{\mathcal{Q}}} Q_{i,k}^Q \varepsilon_k + \sum_{h \in \mathcal{N}_{\mathcal{N}}} Q_{i,h} \varepsilon_h \quad \forall i \in \mathcal{N}_{\mathcal{Q}} \\ \hat{P}_i &= P_{i,0} + \sum_{j \in \mathcal{N}_{\mathcal{P}}} P_{i,j}^P \varepsilon_j + \sum_{k \in \mathcal{N}_{\mathcal{Q}}} P_{i,k}^Q \varepsilon_k + \sum_{h \in \mathcal{N}_{\mathcal{N}}} P_{i,h} \varepsilon_h \quad \forall i \in \mathcal{N}_{\mathcal{P}}\end{aligned}$$

- Starting from this initial affine solution, a “domain contraction” method for narrowing its bounds is used.



# AA-BASED PF

$$\begin{bmatrix} \hat{Q}_1 \\ \dots \\ \hat{Q}_{N_Q} \\ \hat{P}_1 \\ \dots \\ \hat{P}_{N_P} \end{bmatrix} = \begin{bmatrix} Q_{1,0} \\ \dots \\ Q_{N_Q,0} \\ P_{1,0} \\ \dots \\ P_{N_P,0} \end{bmatrix} + \begin{bmatrix} Q_{1,1}^P & \dots & Q_{1,N_P}^P & Q_{1,1}^Q & \dots & Q_{1,N_Q}^Q \\ \dots & \dots & \dots & \dots & \dots & \dots \\ Q_{N_Q,1}^P & \dots & Q_{N_Q,N_P}^P & Q_{N_Q,1}^Q & \dots & Q_{N_Q,N_Q}^Q \\ P_{1,1}^P & \dots & P_{1,N_P}^P & P_{1,1}^Q & \dots & P_{1,N_Q}^Q \\ \dots & \dots & \dots & \dots & \dots & \dots \\ P_{N_P,1}^P & \dots & P_{N_P,N_P}^P & P_{N_P,1}^Q & \dots & P_{N_P,N_Q}^Q \end{bmatrix} \begin{bmatrix} \varepsilon_1 \\ \dots \\ \varepsilon_{N_P} \\ \varepsilon_{N_P+1} \\ \dots \\ \varepsilon_{N_P+N_Q} \end{bmatrix} + \begin{bmatrix} Q_{1,1} & \dots & Q_{1,N_N} \\ \dots & \dots & \dots \\ Q_{N_Q,1} & \dots & Q_{N_Q,N_N} \\ P_{1,1} & \dots & P_{1,N_N} \\ \dots & \dots & \dots \\ P_{N_P,1} & \dots & P_{N_P,N_N} \end{bmatrix} \begin{bmatrix} \varepsilon_{N_P+N_Q+1} \\ \dots \\ \dots \\ \dots \\ \varepsilon_{N_P+N_Q+N_N} \end{bmatrix}$$



# AA-BASED PF

$$\mathbf{F}(\mathbf{X}) = \mathbf{A}\mathbf{X} + \mathbf{B}$$

$$\mathbf{A} = \begin{bmatrix} Q_{1,1}^P & \cdots & Q_{1,N_P}^P & Q_{1,1}^Q & \cdots & Q_{1,N_Q}^Q \\ \cdots & \cdots & \cdots & \cdots & \cdots & \cdots \\ Q_{N_Q,1}^P & \cdots & Q_{N_Q,N_P}^P & Q_{N_Q,1}^Q & \cdots & Q_{N_Q,N_Q}^Q \\ P_{1,1}^P & \cdots & P_{1,N_P}^P & P_{1,1}^Q & \cdots & P_{1,N_Q}^Q \\ \cdots & \cdots & \cdots & \cdots & \cdots & \cdots \\ P_{N_P,1}^P & \cdots & P_{N_P,N_P}^P & P_{N_P,1}^Q & \cdots & P_{N_P,N_Q}^Q \end{bmatrix}$$



# AA-BASED PF

$$\mathbf{X} = \begin{bmatrix} \varepsilon_1 \\ \dots \\ \varepsilon_{N_P} \\ \varepsilon_{N_P+1} \\ \dots \\ \varepsilon_{N_P+N_Q} \end{bmatrix}$$

$$\mathbf{B} = \begin{bmatrix} Q_{1,0} \\ \dots \\ Q_{N_Q,0} \\ P_{1,0} \\ \dots \\ P_{N_P,0} \end{bmatrix} + \begin{bmatrix} Q_{1,1} & \dots & Q_{1,N_N} \\ \dots & \dots & \dots \\ Q_{N_Q,1} & \dots & Q_{N_Q,N_N} \\ P_{1,1} & \dots & P_{1,N_N} \\ \dots & \dots & \dots \\ P_{N_P,1} & \dots & P_{N_P,N_N} \end{bmatrix} \begin{bmatrix} \varepsilon_{N_P+N_Q+1} \\ \dots \\ \dots \\ \dots \\ \dots \\ \varepsilon_{N_P+N_Q+N_N} \end{bmatrix}$$



# AA-BASED PF

The PF solution can then be obtained by contracting the vector  $X$  so that:

$$\mathbf{A}X + \mathbf{B} = \mathbf{F}^{SP}$$

$$\mathbf{F}^{SP} = \begin{bmatrix} [Q_{1,min}^{SP}, Q_{1,max}^{SP}] \\ \dots \\ [Q_{N_Q,min}^{SP}, Q_{N_Q,max}^{SP}] \\ [P_{1,min}^{SP}, P_{1,max}^{SP}] \\ \dots \\ [P_{N_P,min}^{SP}, P_{N_P,max}^{SP}] \end{bmatrix}$$



# AA\_BASED PF

$$\begin{aligned} \min \quad & (\varepsilon_k, \varepsilon_j) \quad \forall k \in \mathcal{N}_Q, \forall j \in \mathcal{N}_P \\ \text{s.t.} \quad & -1 \leq \varepsilon_k \leq 1, \quad -1 \leq \varepsilon_j \leq 1 \\ & \mathit{inf}(\mathbf{C}) \leq \mathbf{AX} \leq \mathit{sup}(\mathbf{C}) \end{aligned}$$

$$\begin{aligned} \max \quad & (\varepsilon_k, \varepsilon_j) \quad \forall k \in \mathcal{N}_Q, \forall j \in \mathcal{N}_P \\ \text{s.t.} \quad & -1 \leq \varepsilon_k \leq 1, \quad -1 \leq \varepsilon_j \leq 1 \\ & \mathit{inf}(\mathbf{C}) \leq \mathbf{AX} \leq \mathit{sup}(\mathbf{C}) \end{aligned}$$



# A UNIFIED PARADIGM FOR PF AND OPF ANALYSIS

- The main idea was to conceptualize a theoretical framework aimed at effectively solving constrained optimizations problems based on an unified AA-based formalism:

$$\begin{aligned} \min_{(\hat{x}, \hat{u})} \quad & f(\hat{x}, \hat{u}) \\ \text{s.t.} \quad & g_j(\hat{x}, \hat{u}) = 0 \quad j = 1, \dots, n \\ & h_k(\hat{x}, \hat{u}) < 0 \quad k = 1, \dots, m \end{aligned}$$





# DEFINITION OF AA OPERATORS

**Definition 1** (Equality operator for affine forms  $\stackrel{A}{=}$ ) *Two affine forms  $\hat{\chi} = \chi_0 + \sum_{k=1}^{p_\chi} \chi_k \varepsilon_k^\chi$  and  $\hat{\psi} = \psi_0 + \sum_{k=1}^{p_\psi} \psi_k \varepsilon_k^\psi$  are equal, i.e.  $\hat{\chi} \stackrel{A}{=} \hat{\psi}$ , if and only if:*

$$\hat{\chi} - \hat{\psi} = \chi_0 - \psi_0 + \sum_{k=1}^{p_\chi} \chi_k \varepsilon_k^\chi - \sum_{k=1}^{p_\psi} \psi_k \varepsilon_k^\psi = 0 \quad (5.2)$$

■

$$\hat{\chi} \stackrel{A}{=} \hat{\psi} \Leftrightarrow \begin{cases} \chi_0 = \psi_0 \\ \varepsilon_k^\chi = \varepsilon_k^\psi \quad \forall k \in [1, p] \\ \chi_k = \psi_k \quad \forall k \in [1, p] \\ p = p_\chi = p_\psi \end{cases}$$



# DEFINITION OF AA OPERATORS

$$(\chi_0 + \chi_1 \varepsilon_1)^2 \stackrel{A}{=} 1 + 0.1 \varepsilon_1$$

There is no way to satisfy this constraint, since the square function is a non-affine operation, which introduces a new and distinct noise symbol  $\varepsilon_2$  as follows:

$$\chi_0^2 + 2\chi_0\chi_1\varepsilon_1 + \chi_2\varepsilon_2 \stackrel{A}{=} 1 + 0.1\varepsilon_1$$



# DEFINITION OF AA OPERATORS

**Definition 2** (Similarity operator for affine forms  $\overset{A}{\approx}$ ) *Two affine forms  $\hat{\chi} = \chi_0 + \sum_{k=1}^{p+p_{na}} \chi_k \varepsilon_k$  and  $\hat{\psi} = \psi_0 + \sum_{k=1}^{p+p_{na}} \psi_k \varepsilon_k$  are similar with an approximation degree  $L_{\chi, \psi}$ , i.e.  $\hat{\chi} \overset{A}{\approx} \hat{\psi}$ , if and only if:*

$$\left( \chi_k = \psi_k \quad \forall k \in [0, p] \right) \wedge \left( L_{\chi, \psi} = \sum_{k=p+1}^{p+p_{na}} (|\chi_k| + |\psi_k|) \right) \quad (5.8)$$

■



# DEFINITION OF AA OPERATORS

**Definition 3** (Inequality operator for affine forms  $\stackrel{A}{<}$ ) *Given two affine forms  $\hat{\chi} = \chi_0 + \sum_{k=1}^{p_\chi} \chi_k \varepsilon_k^\chi$  and  $\hat{\psi} = \psi_0 + \sum_{k=1}^{p_\psi} \psi_k \varepsilon_k^\psi$ , then  $\hat{\chi} \stackrel{A}{<} \hat{\psi}$  if and only if:*

$$\chi_0 + \sum_{k=1}^{p_\chi} |\chi_k| < \psi_0 - \sum_{k=1}^{p_\psi} |\psi_k| \quad (5.10)$$

■



# DEFINITION OF AA OPERATORS

**Definition 4** (Minimization operator for functions of affine forms) *Given a non-linear function  $f : \mathfrak{R} \rightarrow \mathfrak{R}$ , and the affine form  $\hat{\chi} = \chi_0 + \sum_{k=1}^p \chi_k \varepsilon_k$ , then the following AA-based minimization problem:*

$$\min_{\substack{A \\ \hat{\chi}}} f(\hat{\chi}) = f_0(\hat{\chi}) + \sum_{k=1}^p f_k(\hat{\chi}) \varepsilon_k + \sum_{k=p+1}^{p+p_{na}} f_k(\hat{\chi}) \varepsilon_k \quad (5.11)$$

*is equivalent to the following deterministic multi-objective programming problem:*

$$\min_{(\chi_0, \chi_1, \dots, \chi_p)} \left\{ f_0(\chi_0, \chi_1, \dots, \chi_p), \sum_{k=1}^{p+p_{na}} |f_k(\chi_0, \chi_1, \dots, \chi_p)| \right\} \quad (5.12)$$



# A UNIFIED PARADIGM FOR PF AND OPF ANALYSIS

- Starting from the definition of these novel operators, it has been shown that the overall problem can be recasted as the following dual deterministic problem:

$$\begin{aligned} \min_{\hat{z}} \quad & \{f_0(\hat{z}), \sum_{i=1}^{n_z+n_N} |f_i(\hat{z})|\} \\ \text{s.t.} \quad & g_j(\hat{z}) \stackrel{A}{\approx} 0 \quad j = 1, \dots, n \\ & h_k(\hat{z}) \stackrel{A}{<} 0 \quad k = 1, \dots, m \end{aligned}$$



# A UNIFIED PARADIGM FOR PF AND OPF ANALYSIS

- To solve this problem, a two stage solution algorithm has been proposed:
  - » In the first stage, or “nominal state”, it is assumed that no uncertainty affect the system, and hence the corresponding solution can be computed by solving the following deterministic optimization problem:

$$\begin{aligned} \min_{(z_0^1, \dots, z_0^{n_x+n_u})} & f_0(z_0^1, \dots, z_0^{n_x+n_u}) \\ \text{s.t.} & g_j(z_0^1, \dots, z_0^{n_x+n_u}) = 0 \quad \forall j \in [1, n] \\ & h_k(z_0^1, \dots, z_0^{n_x+n_u}) < 0 \quad \forall k \in [1, m] \end{aligned}$$



# A UNIFIED PARADIGM FOR PF AND OPF ANALYSIS

- » In the second stage, or “perturbed state”, the effect of data uncertainty is considered, computing the partial deviations of the unknown state vector by solving the following deterministic optimization problem:

$$\begin{aligned}
 & \min_{(z_1^1, \dots, z_1^{n_x+n_u}, \dots, z_{n_z}^1, \dots, z_{n_z}^{n_x+n_u})} \sum_{i=1}^{n_z+n_N} |f_i(z_1^1, \dots, z_1^{n_x+n_u}, \dots, z_{n_z}^1, \dots, z_{n_z}^{n_x+n_u})| \\
 & \text{s.t.} \quad g_j(z_1^1, \dots, z_1^{n_x+n_u}, \dots, z_{n_z}^1, \dots, z_{n_z}^{n_x+n_u}) \stackrel{A}{\approx} 0 \quad \forall j \in [1, n] \\
 & \quad \quad h_k(z_1^1, \dots, z_1^{n_x+n_u}, \dots, z_{n_z}^1, \dots, z_{n_z}^{n_x+n_u}) \stackrel{A}{<} 0 \quad \forall k \in [1, m]
 \end{aligned}$$





# A UNIFIED PARADIGM FOR PF AND OPF ANALYSIS

$$\begin{aligned} \min_{(\hat{\chi}, \hat{\psi})} \quad & f(\hat{\chi}, \hat{\psi}) = \hat{\chi}^2 + 4\hat{\psi}^2 - (3 + 0.1\epsilon_1 + 0.1\epsilon_2) \\ \text{s.t.} \quad & g(\hat{\chi}, \hat{\psi}) = 4\hat{\chi}^2 - 16\hat{\chi} + \hat{\psi}^2 \stackrel{A}{\approx} -12 + 0.2\epsilon_1 \end{aligned}$$



$$\min_{(\chi_0, \psi_0)} \chi_0^2 + 4\psi_0^2 - 3$$

“Nominal state”

$$\text{s.t. } 4\chi_0^2 - 16\chi_0 + \psi_0^2 + 12 = 0$$

$$\min_{(\chi_1, \chi_2, \psi_1, \psi_2)} |(2\chi_0\chi_1 + 8\psi_0\psi_1 - 0.1)| + |2\chi_0\chi_2 + 8\psi_0\psi_2 - 0.1| + (|\chi_1| + |\chi_2|)^2 + 4(|\psi_1| + |\psi_2|)^2$$

s.t.

$$8\chi_0\chi_1 - 16\chi_1 + 2\psi_0\psi_1 = 0.2$$

$$8\chi_0\chi_2 - 16\chi_2 + 2\psi_0\psi_2 = 0$$

“Perturbed state”

$$\hat{\chi}_s = 1 - 0.026\epsilon_1 = [0.9750, 1.0259]$$

$$\hat{\psi}_s = 0$$

$$f(\hat{\chi}_s, \hat{\psi}_s) = -2 - 0.15\epsilon_1 - 0.1\epsilon_2 + 0.00062\epsilon_3 = [-2.25, -1.75]$$

$$g(\hat{\chi}_s, \hat{\psi}_s) = -12 + 0.2\epsilon_1 + 0.0025\epsilon_3 = [-12.2025, -11.7975]$$

Solution



# A UNIFIED PARADIGM FOR PF AND OPF ANALYSIS

- Compared to the previous proposed AA-based PF and range-arithmetic based OPF, this computing paradigm is expected to improve the solution accuracy.
- Anyway, it resulted in higher computational costs, mainly due to the large number of control variables required to solve the “perturbed state” problem.
- This could pose some computational difficulties for large scale power system applications.
- To address this problem, PCA-based paradigms for knowledge discovery from historical operation data-sets has been proposed.



# KNOWLEDGE DISCOVERY FROM POWER SYSTEMS OPERATION DATA

- PCA-based knowledge discovery paradigms:
  - » Extract actionable information to determine potential patterns and complex features potentially describing regularities in the PF and OPF results.
  - » Simplify the computational burden of the proposed optimization frameworks, thus reducing the complexity of the AA-based PF and OPF.
  - » Better identify the noise symbols of the affine forms by exploring the connections between the principal components and the primitive variables of the affine forms.



# PCA-BASED IDENTIFICATION OF THE NOISE SYMBOLS

- The main idea is to exploit the capacity of PCA in describing the evolution of statistically correlated variables by a linear combination of a limited number of “primitive” variables.
- To discover the potential patterns among these data, the following set of historical observations should be analyzed:

$$[P_i^{SP}(K), Q_j^{SP}(K)]^T \quad \forall i \in N_P, j \in N_Q, K \in [0, \bar{T}]$$



# PCA-BASED IDENTIFICATION OF THE NOISE SYMBOLS

- The application of PCA to this data set allows to represent the injected active and reactive powers as follows:

$$\begin{aligned}P_i^{SP}(K) &= \Omega^P s(K) + P_{i,med}^{SP} & \forall i \in N_P, K \in [0, \bar{T}] \\Q_j^{SP}(K) &= \Omega^Q s(K) + Q_{j,med}^{SP} & \forall j \in N_Q, K \in [0, \bar{T}] \\P_{i,med}^{SP} &= \frac{1}{\bar{T}} \sum_{K=1}^{\bar{T}} P_i^{SP}(K) & \forall i \in N_P \\Q_{j,med}^{SP} &= \frac{1}{\bar{T}} \sum_{K=1}^{\bar{T}} Q_j^{SP}(K) & \forall j \in N_Q\end{aligned}$$



# PCA-BASED IDENTIFICATION OF THE NOISE SYMBOLS

- Hence, the number of noise symbols describing the injected power uncertainties can be set to  $n_{PC}$ , and the corresponding affine forms can be defined as follows:

$$\begin{aligned}\hat{P}_i^{SP} &= P_{i,0}^{SP} + \sum_{k=1}^{n_{PC}} P_{i,k} \varepsilon_k \quad \forall i \in N_P \\ \hat{Q}_j^{SP} &= Q_{j,0}^{SP} + \sum_{k=1}^{n_{PC}} Q_{j,k} \varepsilon_k \quad \forall j \in N_Q\end{aligned}$$

- where the noise symbols represent the uncertainty affecting the principal components.



# PCA-BASED IDENTIFICATION OF THE NOISE SYMBOLS

- The unknown parameters of the affine forms defined can be identified by solving the following system of linear interval equations:

$$\begin{aligned} [P_{i,min}^{SP}, P_{i,max}^{SP}] &= \Omega^P [s_{min}, s_{max}] + P_{i,med}^{SP} & \forall i \in N_P \\ [Q_{j,min}^{SP}, Q_{j,max}^{SP}] &= \Omega^Q [s_{min}, s_{max}] + Q_{j,med}^{SP} & \forall j \in N_Q \end{aligned}$$

- Which yield to the following relations:

$$\begin{aligned} P_{i,0} &= P_{i,med}^{SP} & \forall i \in N_P \\ P_{i,k} &= \Omega_{i,k}^P \frac{s_{k,max} - s_{k,min}}{2} & \forall i \in N_P \\ Q_{j,0} &= Q_{j,med}^{SP} & \forall j \in N_Q \\ Q_{j,k} &= \Omega_{i,k}^Q \frac{s_{k,max} - s_{k,min}}{2} & \forall j \in N_Q \end{aligned}$$





# SIMULATION STUDIES

- Detailed simulation studies were obtained for the several IEEE Node Test Feeders and for a large scale power system.
- The PF and OPF solution tolerances obtained by the proposed AA-based methodologies have been compared to those calculated by a Monte Carlo simulation.
- The input data uncertainties assumed to have a tolerance of  $\pm 20\%$  on loads demand and power generated.



# SIMULATION STUDIES – PF ANALYSIS

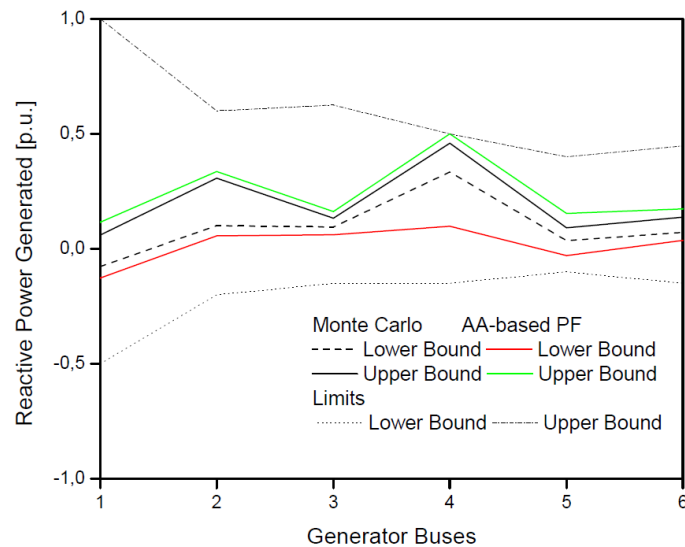
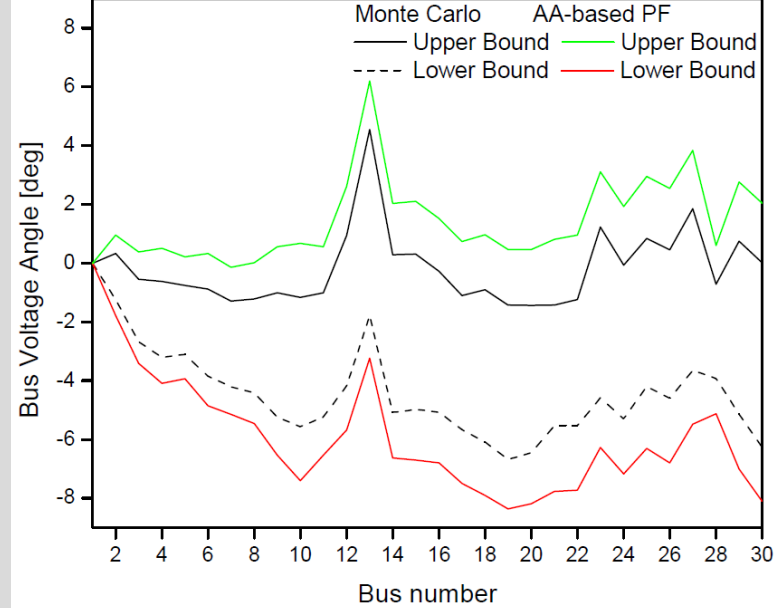
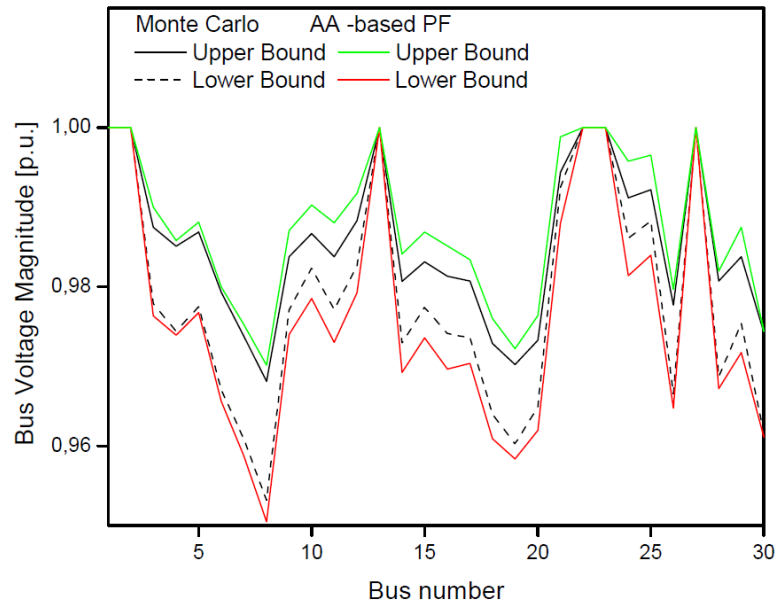

# SIMULATION STUDIES – PF ANALYSIS

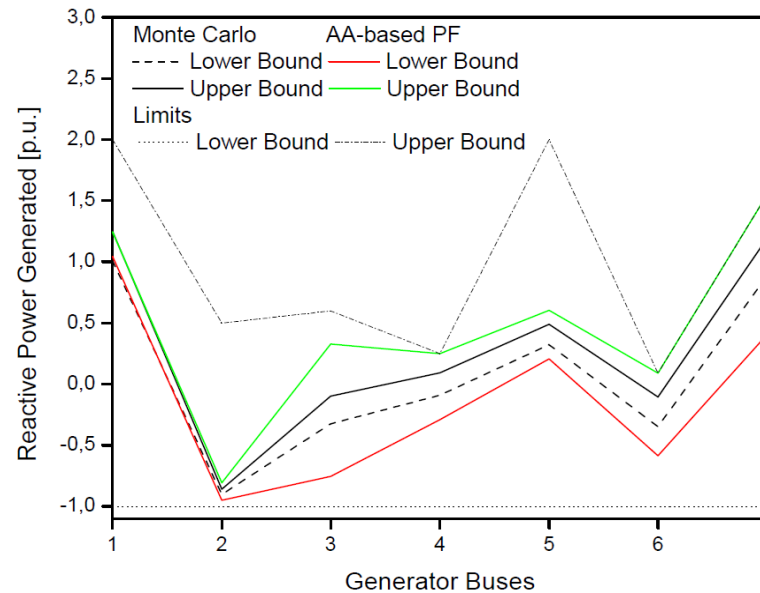
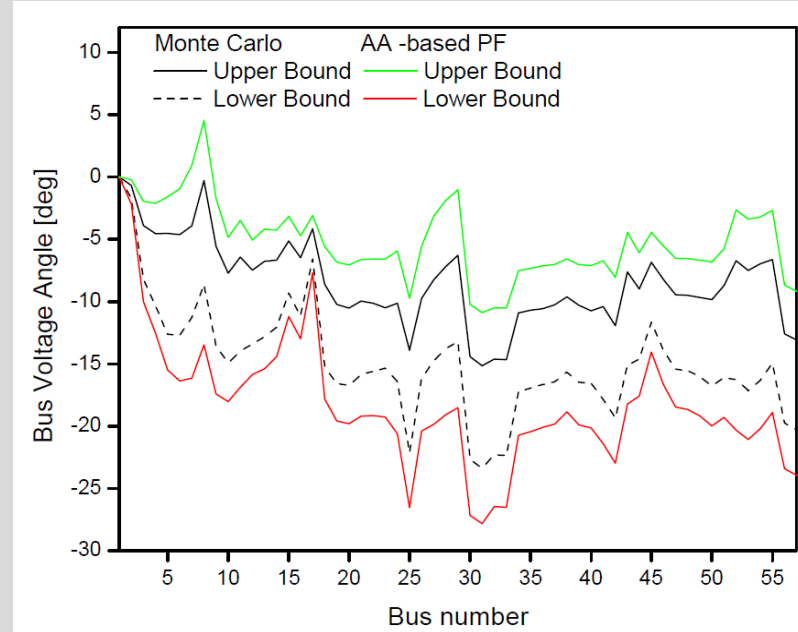
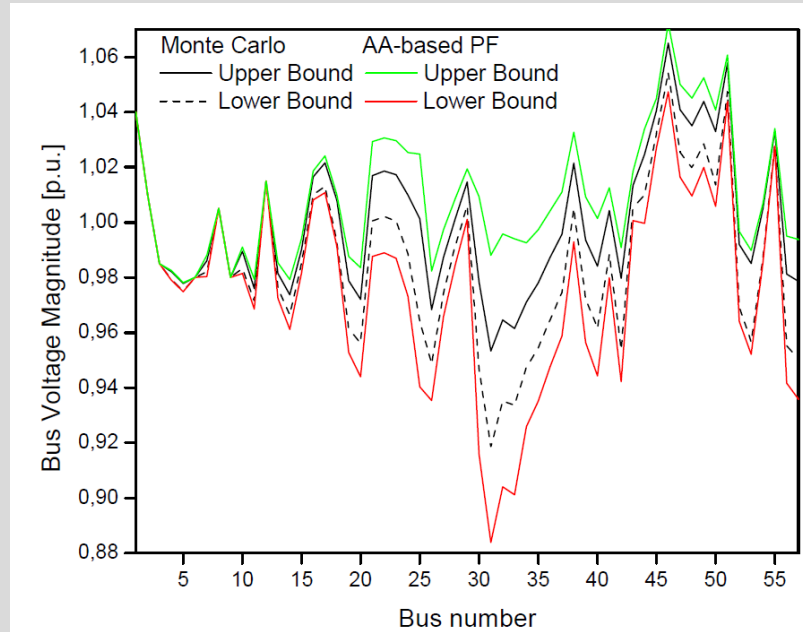

# SIMULATION STUDIES – PF ANALYSIS

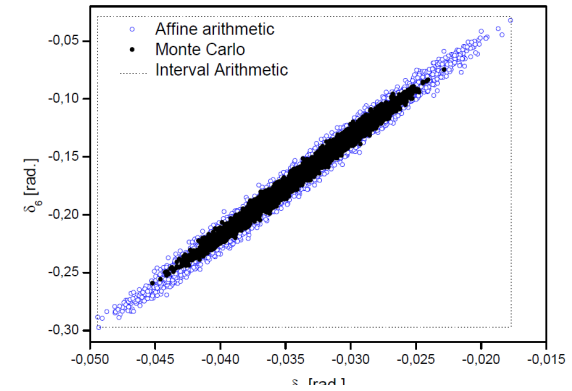
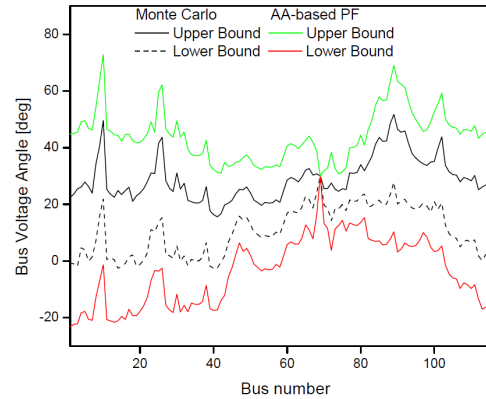
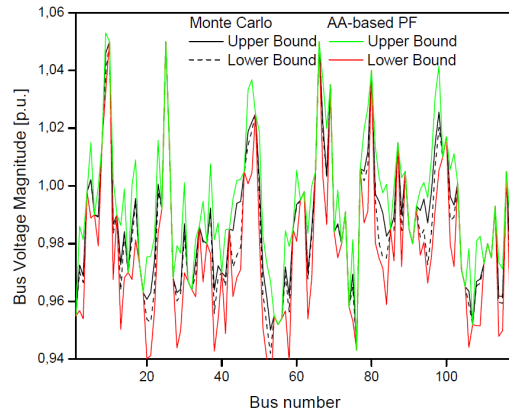
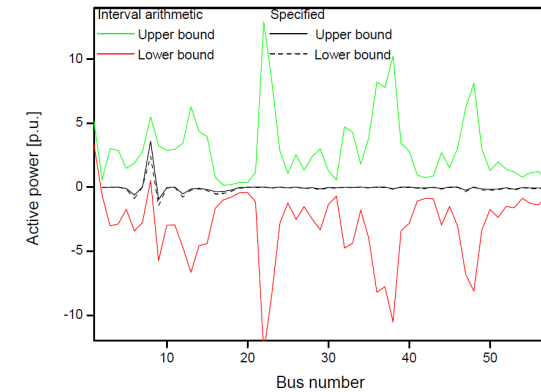

Table 3.1: Average Errors

	30 bus		57 bus		118 bus	
	Upper	Lower	Upper	Lower	Upper	Lower
Bus Voltage Angle [deg]	0.65	0.97	3.32	3.33	3.18	3.16
Bus Voltage Magnitude [p.u.]	0.0055	0.0046	0.009	0.0088	0.0102	0.0101

Table 3.2: Execution Times (seconds)

	30 bus	57 bus	118 bus
Monte Carlo [s]	149.9	211.8	603.1
AA-based PF [s]	1.7	2.5	5.7



# SIMULATION STUDIES – OPF ANALYSIS

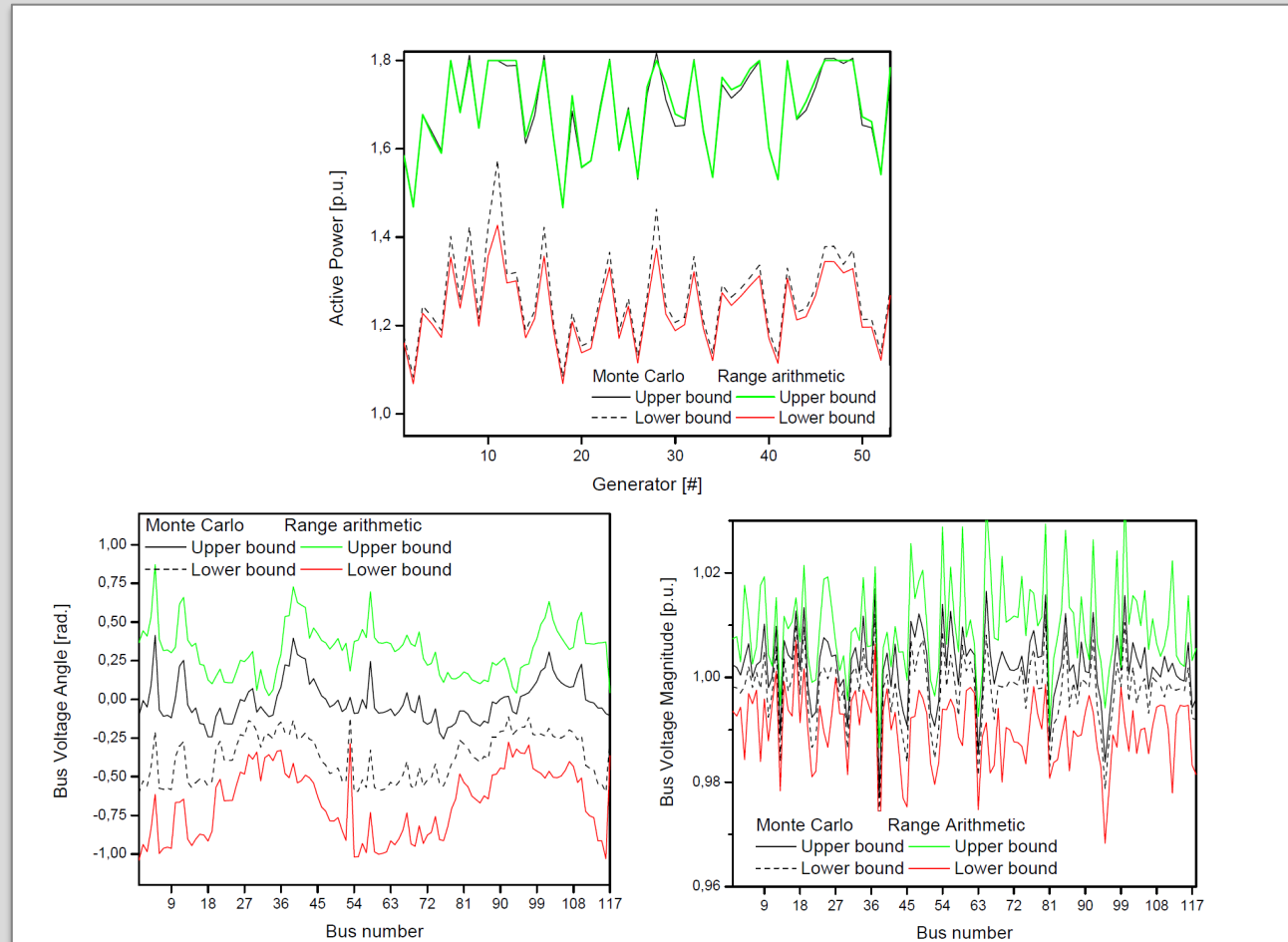

# SIMULATION STUDIES – PF ANALYSIS UNIFIED PARADIGM

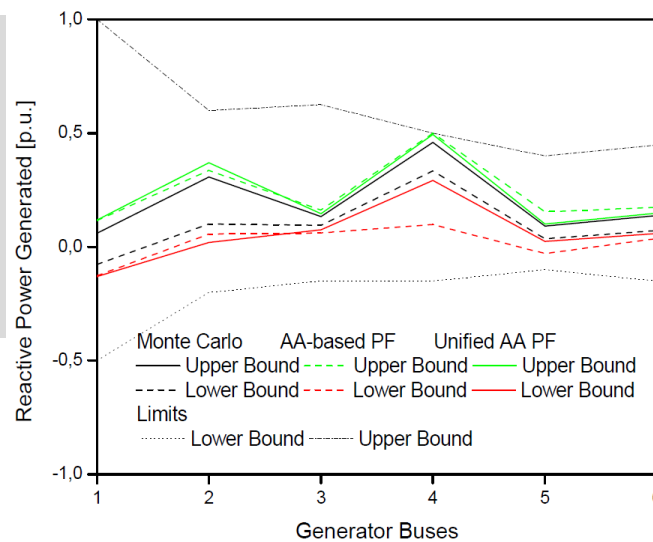
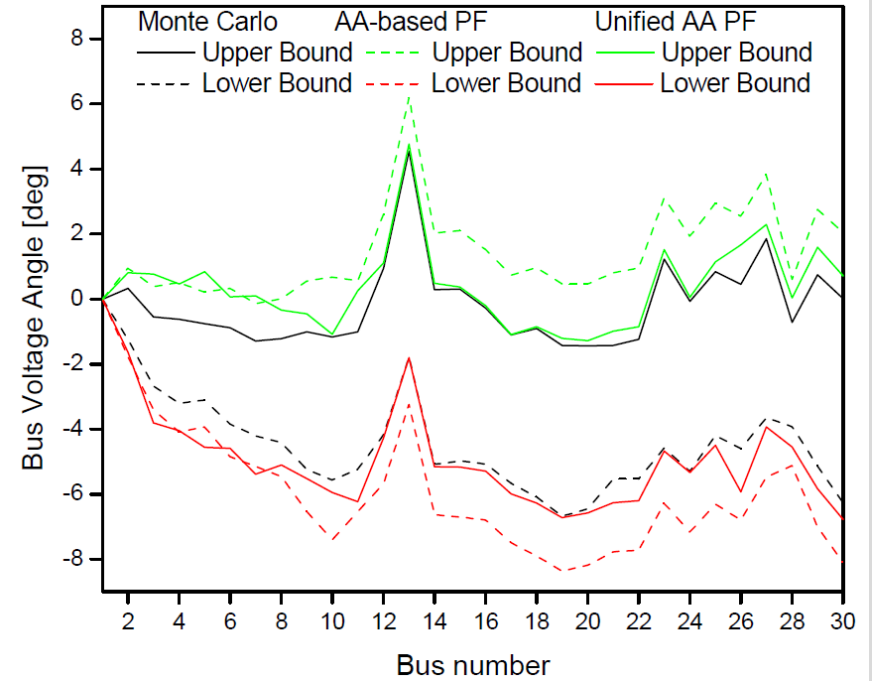
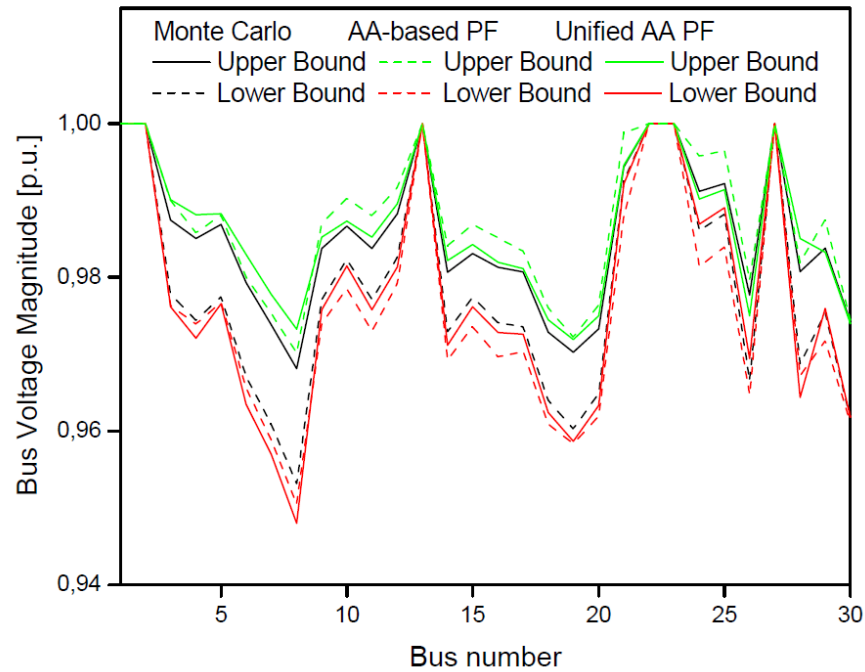

# SIMULATION STUDIES – PF ANALYSIS

## UNIFIED PARADIGM

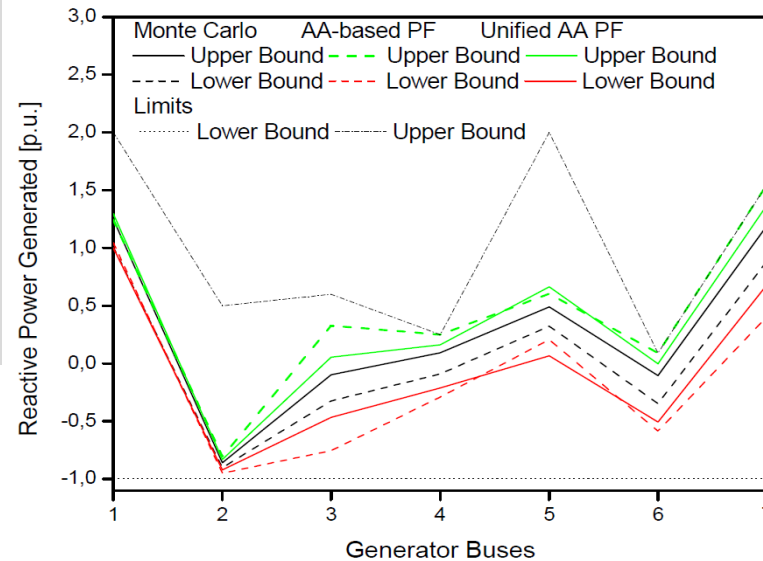
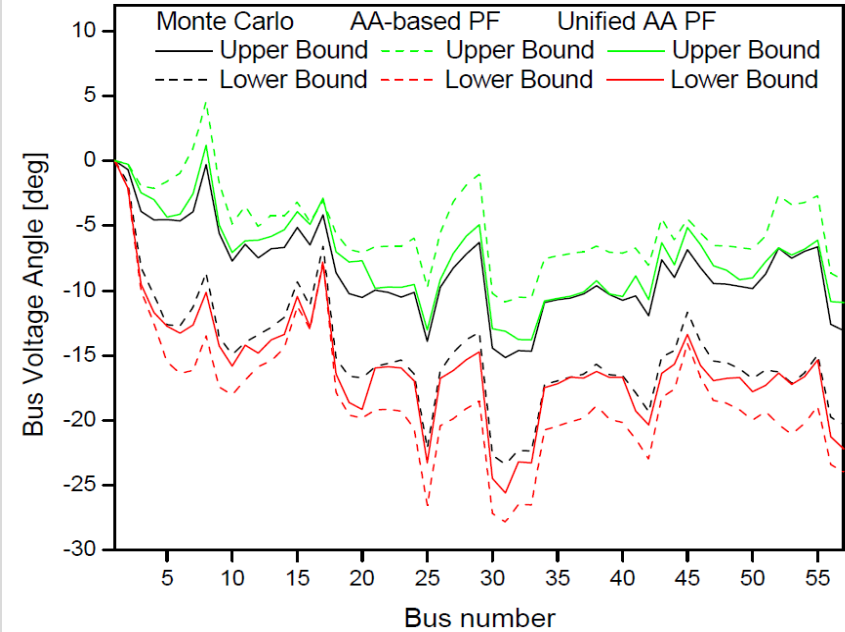
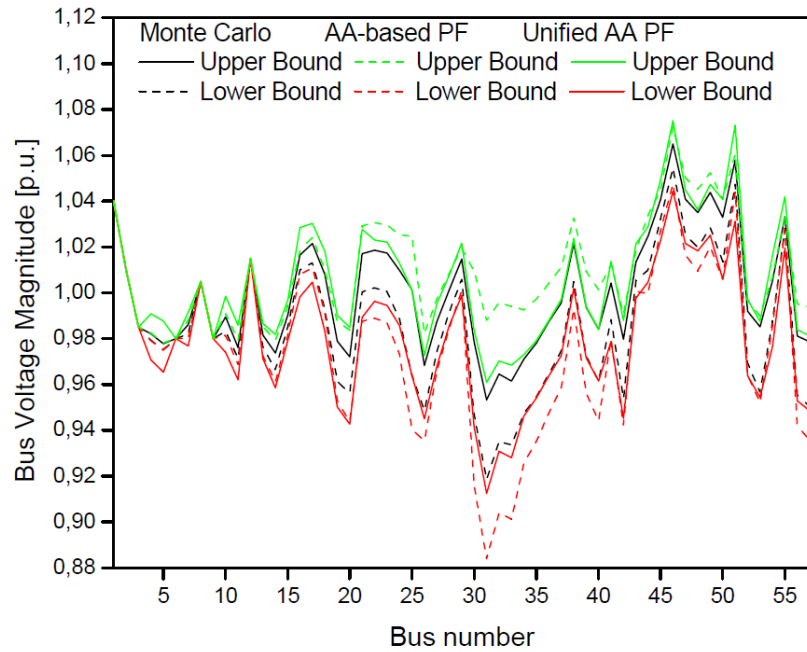

# SIMULATION STUDIES – PF ANALYSIS UNIFIED PARADIGM

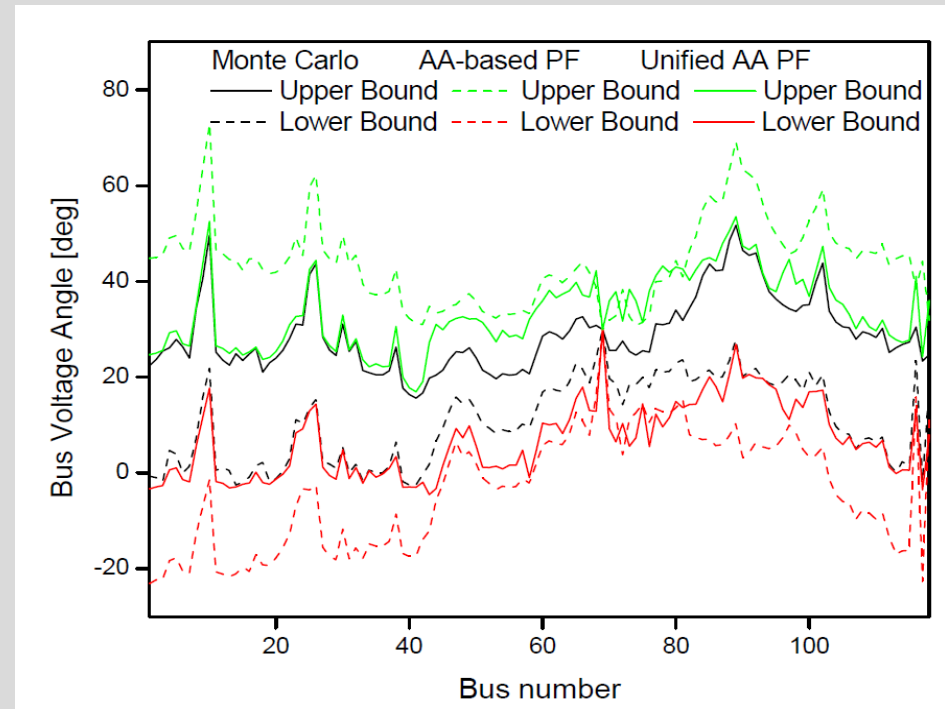
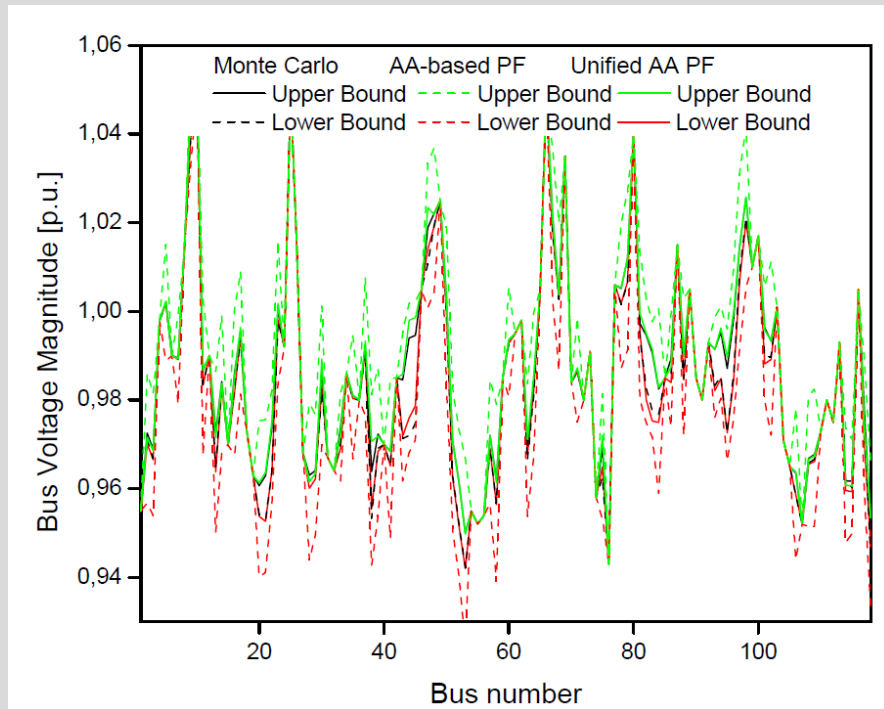



# SIMULATION STUDIES – OPF ANALYSIS UNIFIED PARADIGM

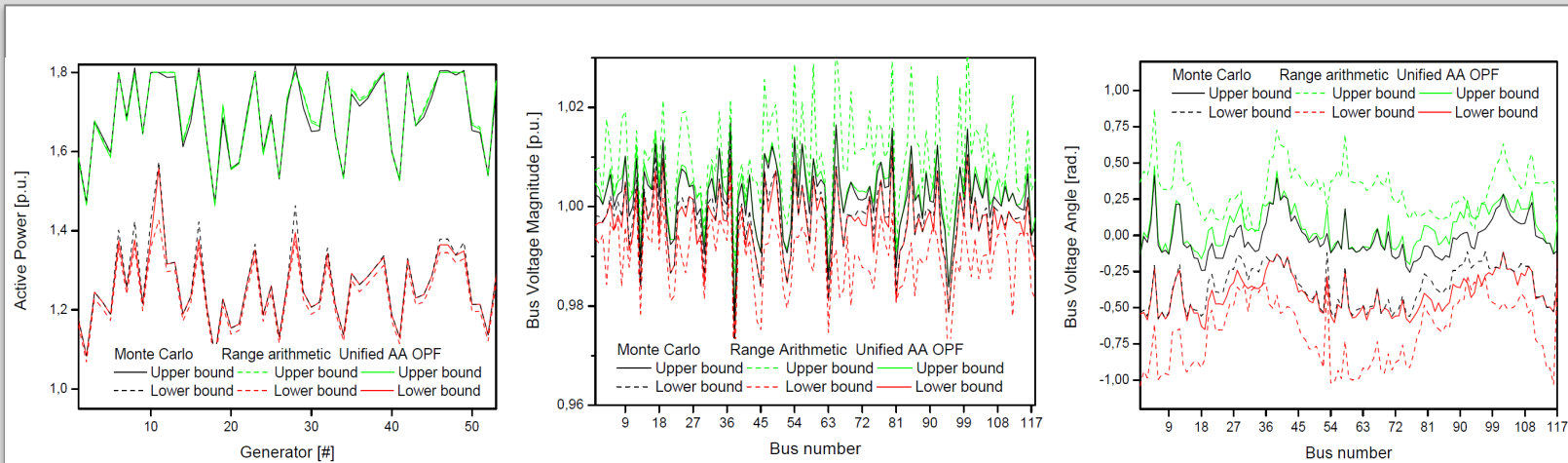

Table 5.1: Average Errors (Bus Voltage Magnitude Bounds)

	30 bus		57 bus		118 bus	
	Upper	Lower	Upper	Lower	Upper	Lower
AA-based PF [p.u.]	0.0055	0.0046	0.009	0.0088	0.0102	0.0101
Unified AA method [p.u.]	0.002	0.003	0.0047	0.0071	0.0062	0.0065

Table 5.2: Average Errors (Bus Voltage Angle Bounds)

	30 bus		57 bus		118 bus	
	Upper	Lower	Upper	Lower	Upper	Lower
AA-based PF [deg]	0.65	0.97	3.32	3.33	3.18	3.16
Unified AA method [deg]	0.26	0.10	0.96	0.98	0.99	0.01

Table 5.3: Execution Times (seconds)

	30 bus	57 bus	118 bus
Monte Carlo [s]	149.9	211.8	603.1
AA-based PF [s]	1.7	2.5	5.7
Unified AA method	110.72	167.8	406.5



# SIMULATION STUDIES – PCA-BASED PF ANALYSIS

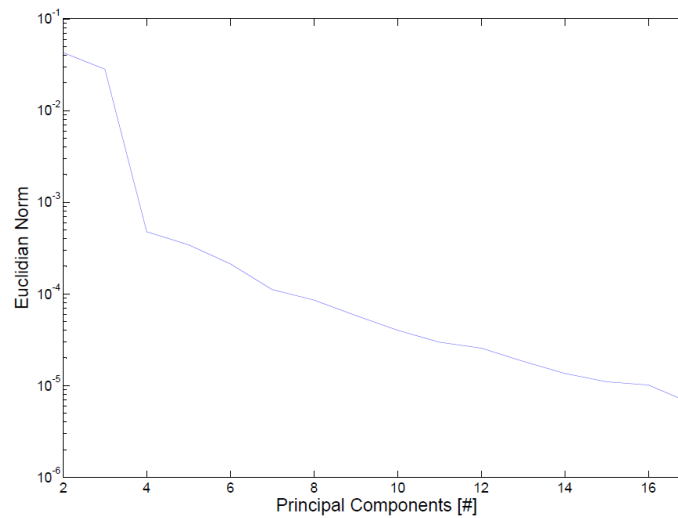
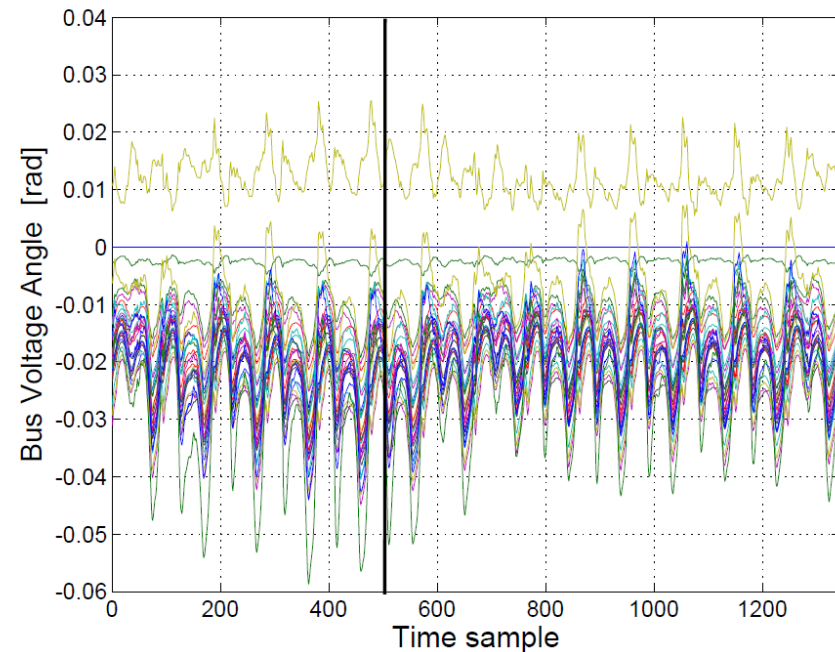
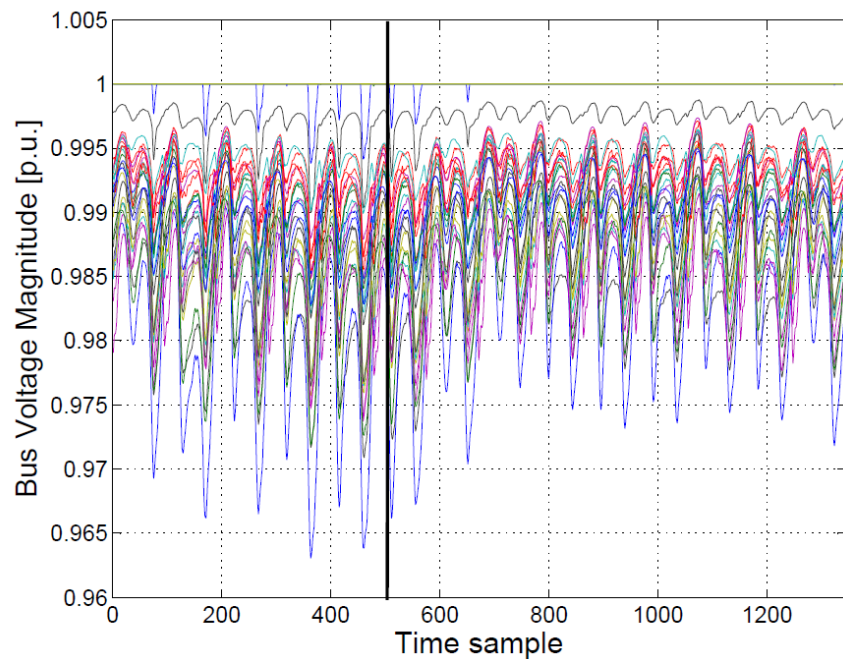

# SIMULATION STUDIES – PCA-BASED PF ANALYSIS

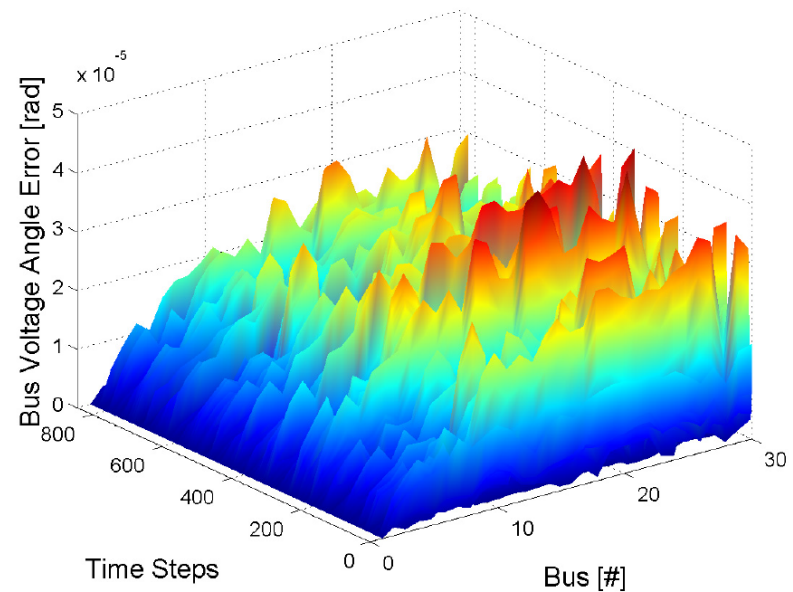
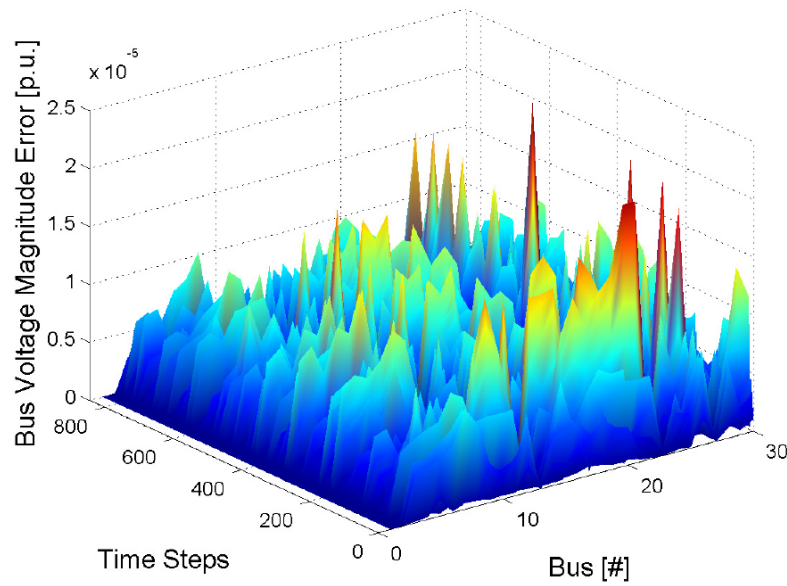
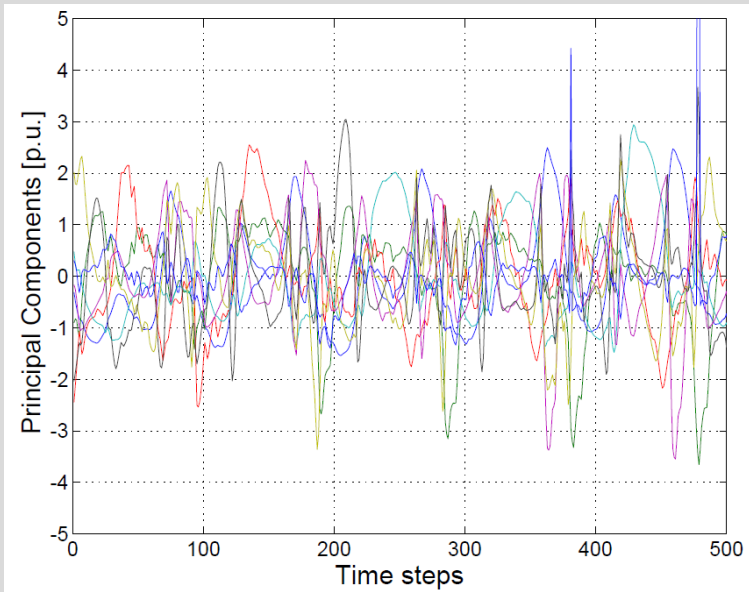

# SIMULATION STUDIES – PCA-BASED PF ANALYSIS

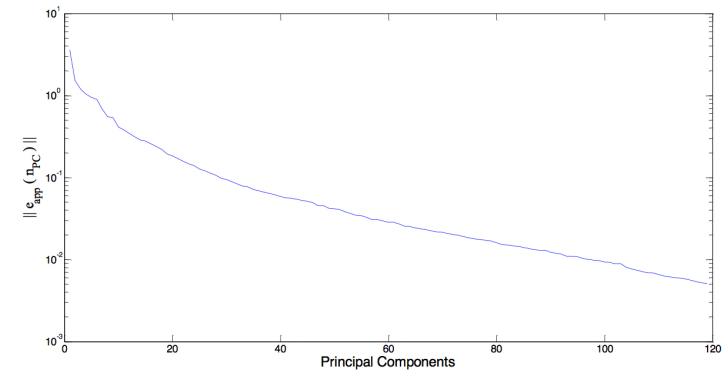
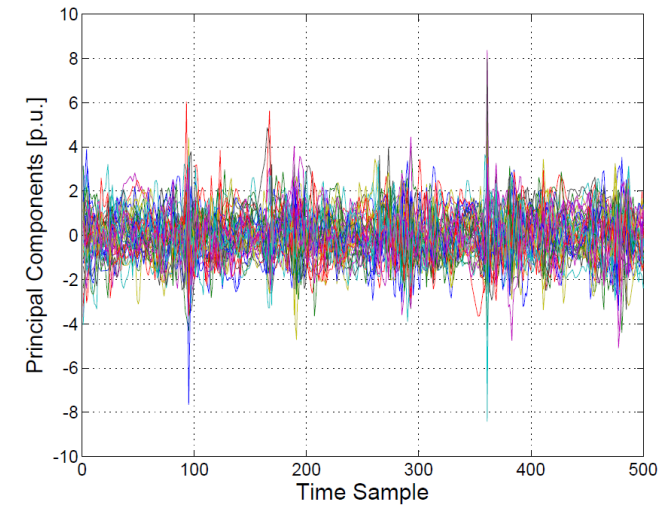
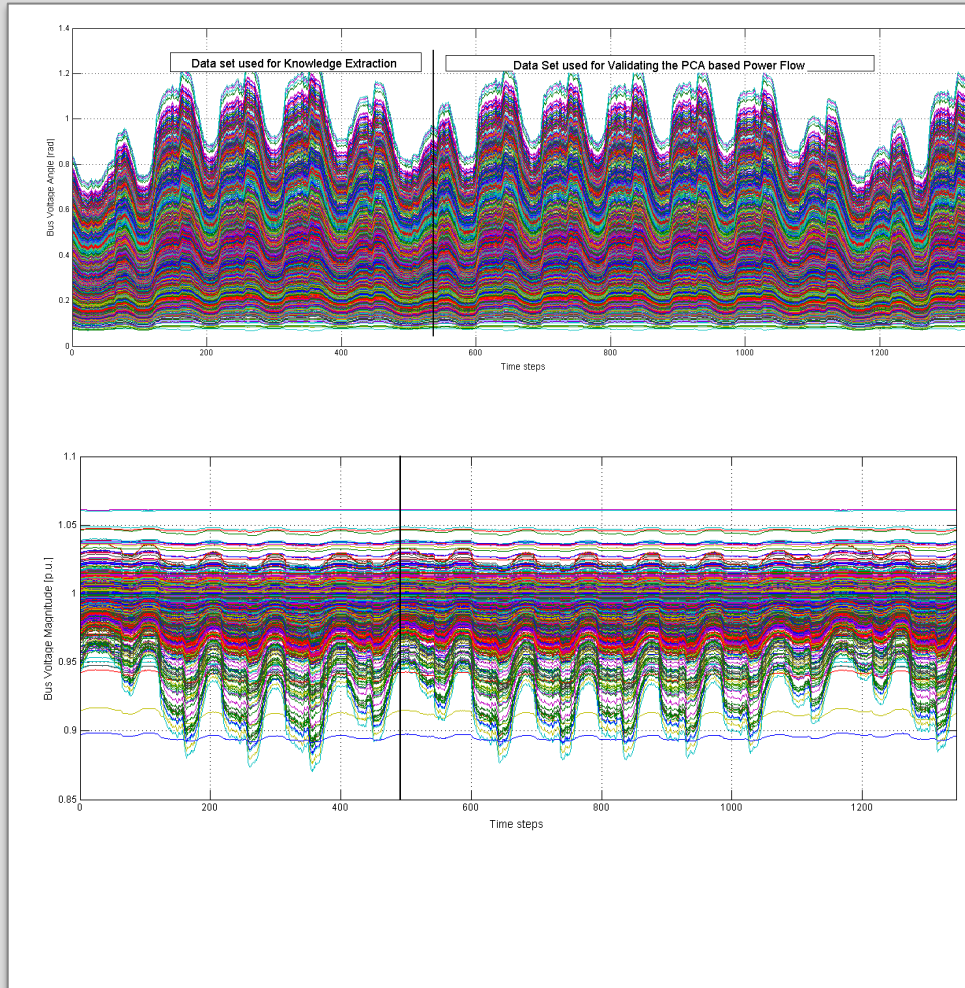

# SIMULATION STUDIES – PCA-BASED PF ANALYSIS

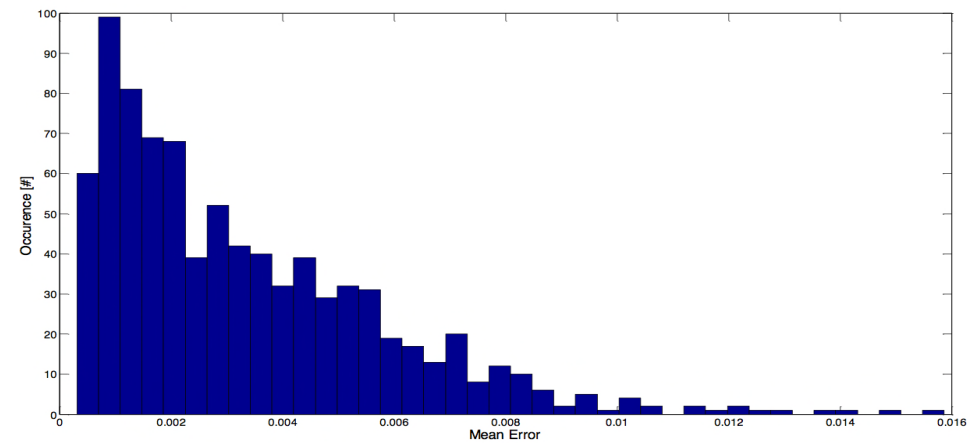
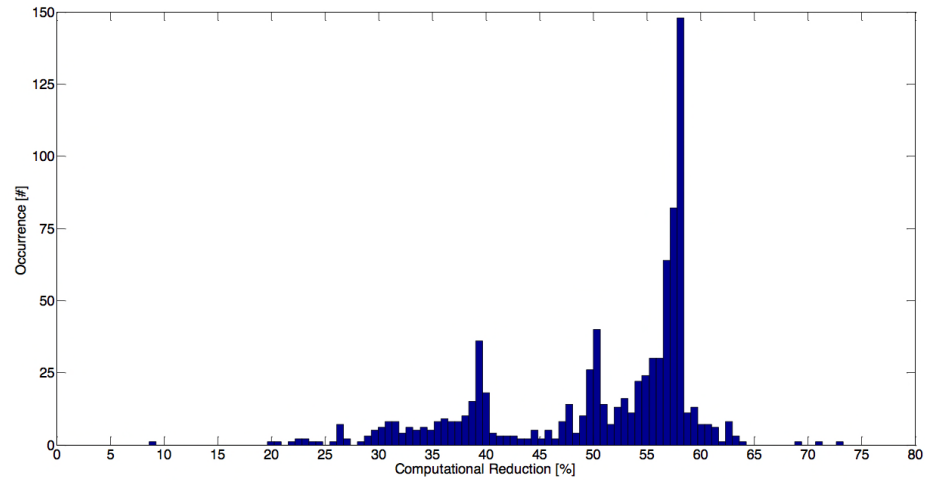

# SIMULATION STUDIES – PCA-BASED OPF ANALYSIS

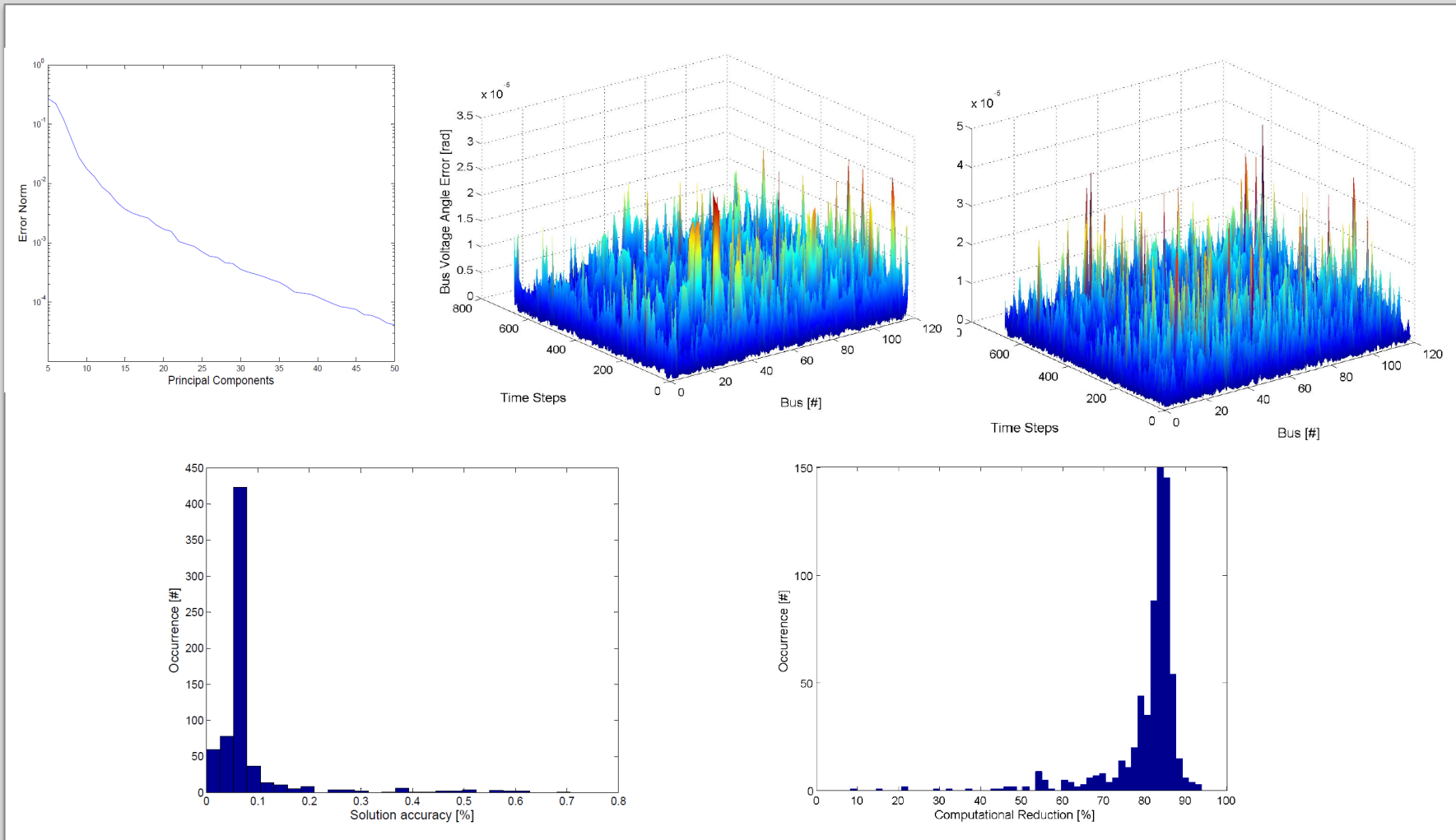

# SIMULATION STUDIES – PCA-BASED IDENTIFICATION OF THE AFFINE FORMS

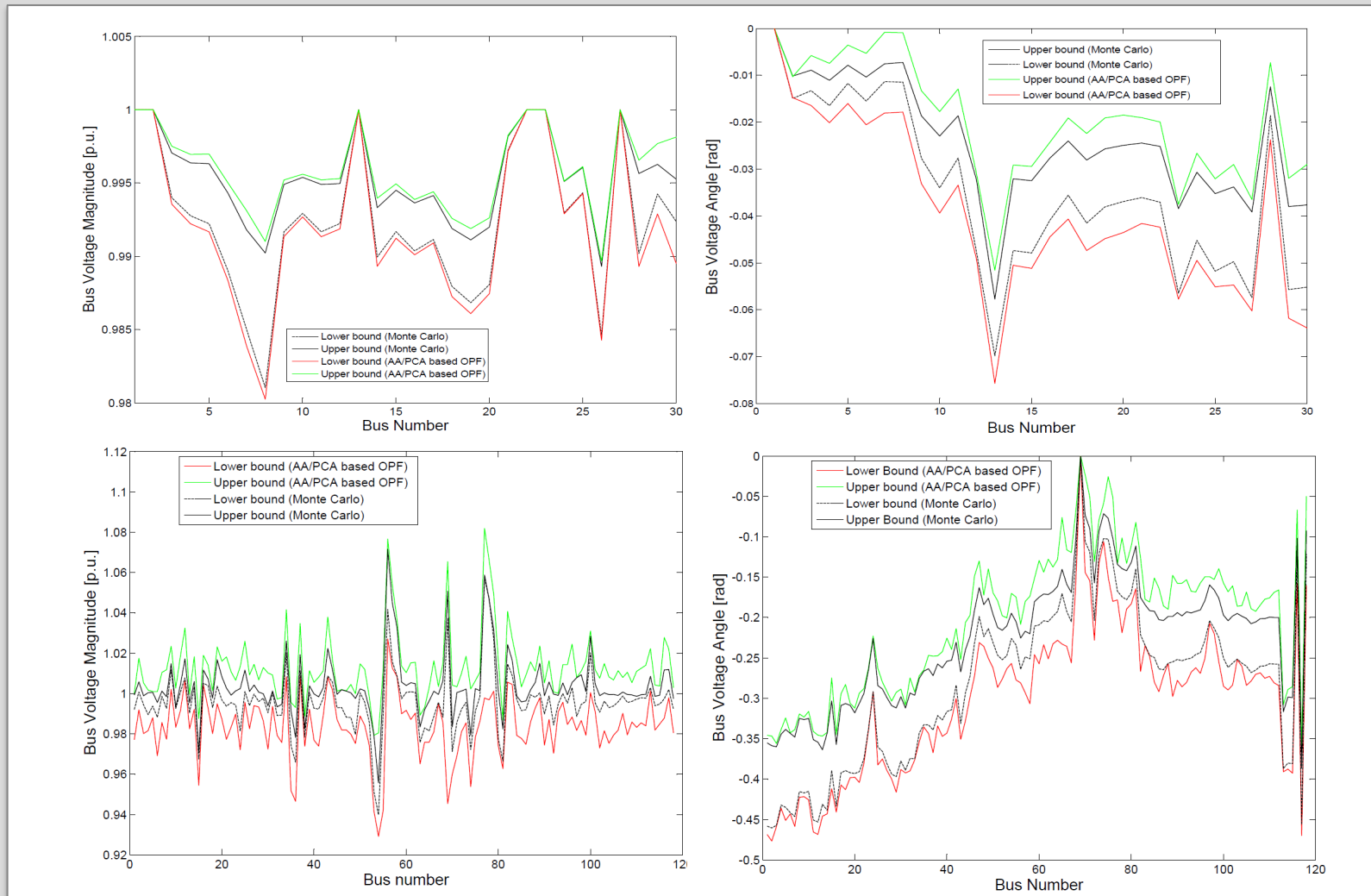

# CONCLUSIVE REMARKS

- This Tutorial analyzed the use of AA-based computing paradigms for solving uncertain PF and OPF problems
- A methodology for AA-based PF analysis that allows to better handle uncertainty compared to the traditional and widely used IA approaches was described
- A domain contraction technique based on range arithmetic was then analyzed for uncertain OPF analysis





# CONCLUSIVE REMARKS

- To reduce the approximation errors of uncertain PF and OPF analyses a novel AA-based computing paradigm was defined
- A PCA-based paradigm for knowledge discovery from historical operation data-sets was proposed to lower the cardinality of PF and OPF problems, and to identify the optimal affine forms



# CONCLUSIVE REMARKS

- On the basis of the obtained results, it could be argued that a power engineer aiming at using AA-based techniques is confronted with an accuracy/complexity trade-off.
- AA techniques based on domain contraction can be used to obtain a rough qualitative insight of the solution in a very short time
- Solution methods based on the definition of formal AA operators can be used to obtain more accurate solution enclosures at the cost of higher simulation times



# CONCLUSIVE REMARKS

- In both cases, the use of PCA can contribute to sensibly reduce the problem cardinality, and to better identify the affine forms describing the data uncertainty.

